



Schranksystem

Contur Loretto

ZR. 718382 – Preis- und Typenliste Stand 01.04.2025

<https://contur-einrichtung.de>

Contur

Pflege und Unterhalt

Lack:

Die Unterhaltspflege ist gleichzusetzen mit der täglichen Körperpflege des Menschen. Das heißt, hier werden Verschmutzungen, die durch den täglichen Gebrauch entstehen, beseitigt. Wichtig ist, dass verschüttete Flüssigkeiten (z. B. Fruchtsäfte) sofort mit einem saugfähigen Küchenpapier oder Tuch abgetupft – nicht gerieben! – werden, damit sie gar nicht erst in die Oberfläche eindringen können.

Unsere Möbel sind mit einem seidenmatten Lack überzogen, der die natürliche Schönheit des Holzes und dessen Porenstruktur nur noch unterstreicht. Verarbeitung und Materialbeschaffenheit machen eine besondere Pflege und teure Pflegemittel nicht erforderlich. Den täglichen Staubputz erledigen Sie mit einem weichen, flusenfreien Reinigungstuch. Dieses kann auch nebelfeucht sein. Hier muss auf jeden Fall trocken nachgerieben werden.

Kaffee-, Tee- oder Alkoholflecken verändern die Oberfläche nicht, sollten aber sofort weggewischt werden. Pflegemittel, die Wachse, Öle, Politurmittel, Lösemittel, Alkohole oder Scheuerpulver enthalten, dürfen nicht verwendet werden. Größere Schrammen oder abgestoßene Kanten lassen Sie bitte von einem Fachmann beseitigen.

Achtung: Verwenden Sie bitte keine Mikrofaser- oder harte Tücher, da diese auf den Oberflächen feine Schlieren, Streifen oder Kratzspuren hinterlassen können. Benutzen Sie auch keine Zusätze von Spiritus, Scheuer- und Lösungsmitteln. Sprühen Sie auch keine Möbelpflegemittel auf die Oberflächen.

Modellbedingte / warentypische Eigenschaften

Besondere Eigenschaften:

Die Lebensgeschichte eines Baumes wird durch charakteristische Wuchsmerkmale wie Zeichnung, Struktur und Farbe geprägt. Kein Baum gleicht dem anderen, wie der Fingerabdruck eines Menschen. Diese abweichenden Natur- und Wachstumsmerkmale machen aus jedem individuell planbaren Echtholzmöbel in modellbezogener Material- und Verarbeitungsstruktur ein echtes Unikat mit einem einzigartigen Erscheinungsbild. Eine absolute Farb- und Strukturgleichheit, beispielsweise zwischen Planungsmuster und Lieferung, kann deshalb nicht garantiert werden. Insbesondere bei Bestellungen aus unterschiedlichen Warengruppen oder späteren Ergänzungen empfiehlt sich daher der Anfertigung nach Frontmuster.

Position und Lichteinfall kann zu hellen und dunklen Farb- und Strukturakzenten. Diese Natur-Farbspiele sind eine warentypische Eigenschaft des gewachsenen Naturwerkstoffes und ein wesentliches, unverwechselbares Echtheitsmerkmal, kein Beanstandungsgrund.

Massivholz:

Massivholz ist ein Naturprodukt. Es ist kein uniformer oder homogener Werkstoff; jeder Baum, jedes Stück Massivholz hat seine eigenen unverwechselbaren Merkmale. Somit haben auch Möbel aus Massivholz besondere Ursprungszeichen und sind ein Unikat aus industrieller Fertigung. Charakteristisch für diesen naturgewachsenen Werkstoff sind Farb- und Strukturunterschiede, Verwachsungen, Unregelmäßigkeiten, Äste, Haar- und Kreuzrisse sowie Spannungen (Drehwuchs), die je nach Holzart und Wuchsgebiet unterschiedlich sind. Es sind Echtheitsmerkmale, die dem Holz erst die natürliche Schönheit verleihen und jedes Stück Möbel zu einem Unikat werden lassen.

Massivholz benötigt im Jahresdurchschnitt 45-55 % rel. Luftfeuchtigkeit und ein Wohnklima von 18-21°C. Auf schwankende Raumtemperaturen und Luftfeuchtigkeit – auch Jahreszeiten bedingt – reagiert Holz. Es „arbeitet“ immer. Spannungen im Holz sowie ein Verziehen, Schwinden oder Reißen des Holzes sind daher nicht immer auszuschließen. Alle vorgenannten Merkmale sind Naturmerkmale und geben keinen Anlass zu Beanstandungen. Funktion, Gebrauch, Wert und Haltbarkeit dieser Möbel werden dadurch nicht beeinträchtigt.

Luftfeuchtigkeit:

Holz ist ein natürlicher Werkstoff, der ständig Feuchtigkeit aufnimmt und wieder abgibt, je nach dem Feuchtigkeitsgehalt der lokalen Umgebung. Darum sollten Möbel keiner extrem großen oder zu geringen Luftfeuchtigkeit ausgesetzt werden. Das Holz beginnt sonst wieder zu arbeiten, sich zu verziehen, offene Leimfugen oder Risse zu zeigen. Das Raumklima, das für Mensch und Pflanzen am besten ist (Medizin und Wissenschaft empfehlen Jahresdurchschnittswerte von 45-55 % Luftfeuchtigkeit bei 18-21 °Celsius, kurzfristige Abweichungen von diesen Empfehlungen schaden nicht), ist auch für Holzmöbel richtig.

Lichteinwirkung bei Möbeln:

Starkes Kunst- und insbesondere Sonnenlicht verändert Oberflächen, besonders Holzoberflächen. Diese Art von „Sonnenbrand“ lässt Naturhölzer vergilben, gebeizte Hölzer ausbleichen. Schützen Sie Ihre wertvollen Möbel unbedingt vor extremer Lichteinwirkung, da eine 100% Lichteinheit materialbedingt nicht zu erreichen ist. Die Urgewalt der Sonne verändert alle Materialien! Besondere Vorsicht ist deshalb in hellen Südzimmern mit viel Glas geboten, dort sollten bei direkter Sonneneinstrahlung Vorhänge oder Jalousien geschlossen werden, da sonst eine Oberfläche schon nach wenigen Wochen an den beschienenen Stellen holzartbezogen heller oder dunkler werden kann.

Holzwerkstoffe:

Holz ist im Möbelbau immer noch die Nummer Eins. Die Qualität eines Produktes ist grundsätzlich nicht davon abhängig, ob ein Möbel aus Holzwerkstoffen oder Massivholz besteht, sondern eher von der Qualität des Materialeinsatzes. Die Spanplatten, mitteldichten Faserplatten, Sperr- oder Tischlerplatten sind von höchster Güte und Qualität. Mit Furnier, Folie oder lackierter Oberfläche stabil und vielfältig einsetzbar. Ihre Inhaltstoffe sind auf absolute Unbedenklichkeit nach den strengen EG Richtlinien nachhaltig geprüft und bescheinigt.

Toleranzen:

Industriell hergestellte Möbel weisen sowohl verarbeitungstechnisch als auch materialbedingt gewisse Toleranzen auf. Maßtoleranzen oder leichte Abweichungen/Versätze z.B. bei Konstruktionen, Farben, Strukturen, Schubladen, verstellbaren Teilen, Applikationen, Glasauflagen Format und Farbe, usw., welche innerhalb der national und international gültigen Normen liegen, stellen somit keinen Sachmangel dar. Vielmehr handelt es sich dabei um „warentypische Eigenschaften“.

Hierbei handelt es sich um „hinzunehmende Produktions- und fertigungstechnische Abweichungen“, die auf den Gebrauch, Funktion, Nutzung, Sicherheit und Lebensdauer keinen Einfluss haben.

Contur

Modellvarianten



Drehtürenschränk Loretto - B ca. 280 cm, Melamin matt, Weiß

Bestellnr: 312329 – Artikel Nr.: 101952

Ausführung:

- Oberfläche Melamin, MT 0C BG Bianco gesso Gips weiß
- Griffausführung Gola OC 121 Zement weiß matt lackiert
- Innenausführung: Stoffoptik Permutt
- 6 türig – 3 Elemente a 90 cm
- je Element 1 Fachböden und 2 Kleiderstange (ital. Ausführung)

Beschreibung:

- Hauptfarbe/-material: Weiß, Holzwerkstoff, Melamin, Gipsweiß
- Einlegeböden: Holzwerkstoff, Melamin, Stoffoptik Perlmutter
- Griffe: Griffleiste, Aluminium

Merkmale:

- Anzahl Türen: 6 Pc
- Anzahl Kleiderstangen: 6 Pc
- Anzahl Böden/Einlegeböden: 3 Pc
- inklusive Montagematerial: Ja

Maße: B 280 cm x T 63 cm x H 239 cm

Listenpreis/Sortimentspreis: 2.824,00 EUR

Typen- und Preisliste

LEGENDE DER KORPUSSE/
ZUBEHÖRTEILE

SMART	Holzagglomeratplatten
1/ONE	Holzagglomeratplatten

ÜBERSICHT TÜREN

SMART	Holzagglomeratplatten
LOGICA	Wabenplatten

ANM.: Unsere Platten haben eine niedrige Formaldehydabgabe (CARB)

LEGENDE DER AUSFÜHRUNGEN

SMART	MT OC BG	RAU	Rau matt Gipsweiß	
	MT OC MP		Rau matt Perlmutt	
	MT OC ARN		Rau matt Arena	
	MT OC BA		Rau matt Basaltgrau	
	MT OC MA		Rau matt Mergel	
	MT OC AN		Rau matt Anthrazit	
	MT PA BG		Rau offenporig Gipsweiß	
	MT PA MP		Rau offenporig Perlmutt	
	MT RSB		Rau Eiche Sand	
	MT RMK		Rau Eiche Mokka	
	MT RC		Rau Eiche Kohlegrau	
	MT RNC		Rau astig hell	
	MT RNN		Rau astig Natur	
	MT CC		Rau Zement hell	
	MT CV		Rau Zement Cava	
	MT CLC		Rau Kalk hell	
	MT CLS		Rau Kalk dunkel	
	MT OBR		Rau Oxid brüniert	
	MT ALP		Rau Alpaca	
	1/ONE OC BG		1/ONE matt Gipsweiß	
	1/ONE OC MP	1/ONE matt Perlmutt		
	1/ONE OC ARN	1/ONE matt Arena		
	1/ONE OC BA	1/ONE matt Basaltgrau		
	OC	In Farbe matt lackiert		
	PA	Offenporig lackiert		
	LC	In Farbe glänzend lackiert		
	OCM	Metallic-Lackierung		
			LACKIERT	

Nur wo vorgesehen

MT RNS	RAU	Rau astig dunkel
MT CS		Rau Zement dunkel
MT INT C		Rau Geflecht hell
MT PB		Rau Stroh Bronze
MT PG		Rau Stroh Grau
MT MB		Rau Maya Bronze
LGN NAM	HOLZ	Holz Nussbaum Bernstein
LGN RSB		Holz Eiche Sand
LGN RMK		Holz Eiche Mokka
LGN RC		Holz Eiche Kohlegrau
LGN RNC		Holz astig hell
LGN RNS		Holz astig dunkel
LGN RNN		Holz astig Natur

AKTUALISIERUNG DER AUSFÜHRUNGEN

Aufkleber für die zweite Umschlagseite
der Preisliste 07-2024 SYSTEM SCHRÄNKE

PREISLISTE 07-2024 SCHRÄNKE DREHTÜREN	TÜR		EINSATZ	
	MT PREMIUM	HOLZ	MT PREMIUM	HOLZ
	MT RCG	LGN RCG	MT RCG	LGN RCG
	MT PREMIUM MT RCG Eiche Cognac		HOLZ LGN RCG Eiche Cognac	
DORIS	√	-	-	-
DREHTÜR GOLA	√	-	-	-

PREISLISTE 07-2024 SCHRÄNKE SCHIEBETÜREN	TÜR		EINSATZ	
	MT PREMIUM	HOLZ	MT PREMIUM	HOLZ
	MT RCG	LGN RCG	MT RCG	LGN RCG
	MT PREMIUM MT RCG Eiche Cognac		HOLZ LGN RCG Eiche Cognac	
ATHENA	√	-	√	-
DORIS	√	-	-	-
SCHIEBETÜR GOLA	√	-	-	-

Modul offenes Fach Drehtür in der Ausführung
Rau Eiche Cognac MT RCG erhältlich

Neue Innenausführung für Struktur Eiche
SMART: Rau Eiche Caffè MT RCF

Neue Ausführung für Rückwand, innen
Struktur: Lackiert, matt Geflecht OC INT,
Maße siehe S. 220-221
unter: Aufpreis nur Rückwand innen matt
farbig lackiert OC

Contur

Typen- und Preisliste

INHALTSVERZEICHNIS

GARDEROBE

- 02 Typenübersicht Drehtüren
- 04 Typenübersicht Schiebetüren
- 06 Übersicht der Seitenwände für Zusammenstellungen mit Struktur SMART
- 08 Modulübersicht Schrank mit Drehtür SMART
- 10 Modulübersicht Schrank mit Schiebetür SMART
- 12 Schrankkabine
- 13 Regeln für Schränke mit kombinierten Türsystemen SMART
- 14 Module und Zusammenstellungen mit Tür DORIS - GOLA
- 24 Offenes Modul (Drehtür) T,59,5
- 26 Module und Zusammenstellungen mit Tür ATHENA
- 32 Module und Zusammenstellungen mit Tür DORIS - DORIS 2 SETTORI
- 38 Struktur für Mittleres Bücherregal
 - Module für Abschluss-Bücherregal
- 40 Module mit Drehtür TV-PANEEL
- 44 Aufsätze für Innenlackierung
- 46 Struktur für Offene Schrankkabine
- 48 Innenausstattung
- 62 Aufpreise für Beleuchtung Türen DORIS - ATHENA
- 63 Zuschnitte nach Maß bei Modulen SMART
- 64 Passleisten
- 66 Allgemeine Geschäftsbedingungen

Die Maße sind in Zentimeter angegeben. Die Preise sind in Euro angegeben.



PRATICO SYSTEM

- 74 Modulübersicht
- 76 Wandverkleidung - Profile
- 82 Fachböden
- 85 Bodenstehende Schubladenelemente
- 90 Wandhängende Schubladenelemente
- 92 Halterungen
- 93 Raster
- 94 Struktur Ausziehbare Tablett
- 96 Einzelne Schubladen und Schubkasten
- 98 Zuschnitte nach Maß und Beleuchtung
- 101 Insel

BEILMÖBEL - BETTEN - COMPLEMENTI - BEISTELLTISCHE

- 119 Beilmöbel ARGO
- 121 Beilmöbel ATHENA
- 123 Beilmöbel VINCI
- 125 BETTEN
- 135 COMPLEMENTI
- 137 BEISTELLTISCHE

TYPENÜBERSICHT DREHTÜREN

DORIS



Modulübersicht

H. 223 - 239 - 255 - 287 cm
B. 43,7 - 47,7 - 57,3 - 90 - 98 - 117,2 cm

Türausführung

MT OC BG	MT PA MP	MT OBR
MT OC MP	MT RSB	1/ONE OC BG
MT OC ARN	MT RMK	1/ONE OC MP
MT OC BA	MT RNC	1/ONE OC ARN
MT OC MA	MT RNN	1/ONE OC BA
MT OC AN	MT RC	OC
MT PA BG	MT CC	PA
	MT CV	LC
	MT CLC	OCM
	MT CLS	
	MT ALP	



Integrierter Griff*

OC * Für matte, glänzende oder offenporige Ausführungen Griff in Farbe der Tür.
OCM Für weitere Ausführungen verweisen wir auf die empfohlenen Kombinationen auf Seite 43

GOLA



Modulübersicht Tür SMART

H. 223 - 239 - 255 - 287 cm
B. 43,7 - 47,7 - 57,3 - 90 - 98 - 117,2 cm

Türausführung

MT OC BG	MT PA MP	MT OBR
MT OC MP	MT RSB	1/ONE OC BG
MT OC ARN	MT RMK	1/ONE OC MP
MT OC BA	MT RNC	1/ONE OC ARN
MT OC MA	MT RNN	1/ONE OC BA
MT OC AN	MT RC	OC
MT PA BG	MT CC	PA
	MT CV	LC
	MT CLC	OCM
	MT CLS	
	MT ALP	

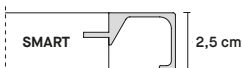

Integrierter Griff*

OC * Für matte, glänzende oder offenporige Ausführungen Griff in Farbe der Tür.
OCM Für weitere Ausführungen verweisen wir auf die empfohlenen Kombinationen auf Seite 43

OFFENES ABSCHLUSSMODUL



VERSION 1*
Offenes Abschlusselement

* Beispiele für H. 255 cm

Modulübersicht

H. 223 - 239 - 255 - 287 cm
B. 90 - 98 - 117,2 cm

Ausführung

MT OC BG	MT OC AN	MT CV
MT OC MP	MT PA BG	MT CLC
MT OC ARN	MT PA MP	MT CLS
MT OC BA	MT RSB	MT ALP
MT OC MA	MT RMK	MT OBR
	MT RNC	OC
	MT RNN	PA
	MT RC	
	MT CC	



VERSION 2*
Offenes Abschlusselement



VERSION 3*
Offenes Abschlusselement



VERSION 4*
Offenes Abschlusselement

TYPENÜBERSICHT SCHIEBETÜREN

ATHENA



Modulübersicht

H. 223 - 239 - 255 cm
B. 90 - 98 - 117,2 - 136,2 cm

Türausführung

MT OC BG	MT PA BG	MT CLS
MT OC MP	MT PA MP	MT ALP
MT OC ARN	MT RSB	MT OBR
MT OC BA	MT RMK	1/ONE OC BG
MT OC MA	MT RNC	1/ONE OC MP
MT OC AN	MT RNN	1/ONE OC ARN
	MT RC	1/ONE OC BA
	MT CC	OC
	MT CV	PA
	MT CLC	

SMART 2,5 cm

Mittlere Platte

MT OC BG	MT OC MA	MT RSB	MT RC	MT CLS	OC
MT OC MP	MT OC AN	MT RMK	MT CC	MT ALP	PA
MT OC ARN	MT PA BG	MT RNC	MT CV	MT OBR	
MT OC BA	MT PA MP	MT RNN	MT CLC		

Griffeinsatz

MT RSB	MT RC	MT CLS	MT OBR	Glänzendes Glas
MT RMK	MT CC	MT MB	MT INT C	Grauer Spiegel 383
MT RNC	MT CV	MT PB	OC	
MT RNN	MT CS	MT PG	PA	
MT RNS	MT CLC	MT ALP		

DORIS



Modulübersicht

H. 223 - 239 - 255 - 287 cm
B. 90 - 98 - 117,2 cm

Türausführung

MT OC BG	MT PA MP	MT OBR
MT OC MP	MT RSB	OC
MT OC ARN	MT RMK	PA
MT OC BA	MT RNC	LC
MT OC MA	MT RNN	OCM
MT OC AN	MT RC	
MT PA BG	MT CC	
	MT CLC	
	MT CLS	
	MT ALP	

SMART 2,5 cm

Integrierter Griff*

OC	* Für matte, glänzende oder offenporige Ausführungen Griff in Farbe der Tür.
OCM	Für weitere Ausführungen verweisen wir auf die empfohlenen Kombinationen auf Seite 43

TYPENÜBERSICHT SCHIEBETÜREN

DORIS 2 SETTORI

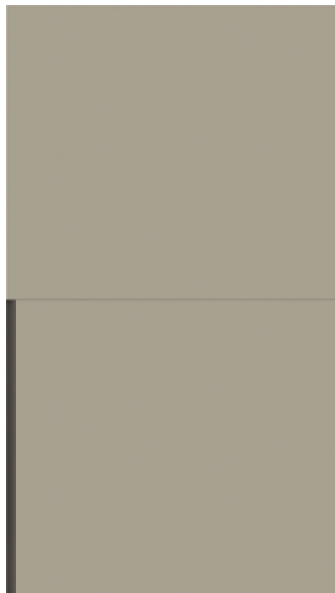

Modulübersicht

H. 223 - 239 - 255 cm
B. 136,2 cm

Türausführung

MT OC BG	MT PA MP	MT OBR
MT OC MP	MT RSB	1/ONE OC BG
MT OC ARN	MT RMK	1/ONE OC MP
MT OC BA	MT RNC	1/ONE OC ARN
MT OC MA	MT RNN	1/ONE OC BA
MT OC AN	MT RC	OC
MT PA BG	MT CC	PA
	MT CV	LC
	MT CLC	OCM
	MT CLS	
	MT ALP	



Integrierter Griff*

OC * Für matte, glänzende oder offenporige Ausführungen Griff in Farbe der Tür.
OCM Für weitere Ausführungen verweisen wir auf die empfohlenen Kombinationen auf Seite 43

GOLA - GOLA VETRO/SPECCHIO



Modulübersicht Tür SMART

H. 223 - 239 - 255 - 287 cm
B. 90 - 98 - 117,2 cm

Türausführung

MT OC BG	MT PA MP	MT OBR
MT OC MP	MT RSB	1/ONE OC BG
MT OC ARN	MT RMK	1/ONE OC MP
MT OC BA	MT RNC	1/ONE OC ARN
MT OC MA	MT RNN	1/ONE OC BA
MT OC AN	MT RC	OC
MT PA BG	MT CC	PA
	MT CV	LC
	MT CLC	OCM
	MT CLS	
	MT ALP	

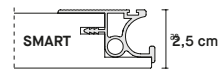

Integrierter Griff*

OC * Für matte, glänzende oder offenporige Ausführungen Griff in Farbe der Tür.
OCM Für weitere Ausführungen verweisen wir auf die empfohlenen Kombinationen auf Seite 43

ÜBERSICHT DER SEITENWÄNDE FÜR ZUSAMMENSTELLUNGEN MIT STRUKTUR **SMART**

Türtyp	Türausführung	Außenausführung Seitenwände	Innenausführung Seitenwände
	MT OC BG Rau matt Gipsweiß	MT OC BG Rau matt Gipsweiß	MT OC BG Rau matt Gipsweiß TRAMATO Stoffoptik MT ALP Rau Alpaca
	MT OC MP Rau matt Perlmutt	MT OC MP Rau matt Perlmutt	MT OC MP Rau matt Perlmutt TRAMATO Stoffoptik MT ALP Rau Alpaca
	MT OC AN Rau matt Anthrazit	MT OC AN Rau matt Anthrazit	MT OC AN Rau matt Anthrazit TRAMATO Stoffoptik MT ALP Rau Alpaca
	MT OC ARN Rau matt Beige	MT OC ARN Rau matt Beige	MT OC ARN Rau matt Beige TRAMATO Stoffoptik MT ALP Rau Alpaca
	MT OC BA Rau matt Basaltgrau	MT OC BA Rau matt Basaltgrau	MT OC BA Rau matt Basaltgrau TRAMATO Stoffoptik MT ALP Rau Alpaca
	MT OC MA Rau matt Mergel	MT OC MA Rau matt Mergel	MT OC MA Rau matt Mergel TRAMATO Stoffoptik MT ALP Rau Alpaca
	MT PA BG Rau offenporig Gipsweiß	MT PA BG Rau offenporig Gipsweiß	MT PA BG Rau offenporig Gipsweiß TRAMATO Stoffoptik MT ALP Rau Alpaca
	MT PA MP Rau offenporig Perlmutt	MT PA MP Rau offenporig Perlmutt	MT PA MP Rau offenporig Perlmutt TRAMATO Stoffoptik MT ALP Rau Alpaca
	MT RC Rau Eiche Kohlegrau	MT RC Rau Eiche Kohlegrau	MT RC Rau Eiche Kohlegrau TRAMATO Stoffoptik MT ALP Rau Alpaca
	MT CC Rau Zement hell	MT CC Rau Zement hell	MT CC Rau Zement hell TRAMATO Stoffoptik MT ALP Rau Alpaca
	MT CV Rau Zement Cava.	MT CV Rau Zement Cava.	MT CV Rau Zement Cava. TRAMATO Stoffoptik MT ALP Rau Alpaca
	MT CLC Rau Kalk hell	MT CLC Rau Kalk hell	MT CLC Rau Kalk hell TRAMATO Stoffoptik MT ALP Rau Alpaca
	MT CLS Rau Kalk dunkel	MT CLS Rau Kalk dunkel	MT CLS Rau Kalk dunkel TRAMATO Stoffoptik MT ALP Rau Alpaca
	MT RNC Rau astig hell	MT RNC Rau astig hell	MT RNC Rau astig hell TRAMATO Stoffoptik MT ALP Rau Alpaca
	MT RNN Rau astig Natur	MT RNN Rau astig Natur	MT RNN Rau astig Natur TRAMATO Stoffoptik MT ALP Rau Alpaca
	MT RSB Rau Eiche Sand	MT RSB Rau Eiche Sand	MT RSB Rau Eiche Sand TRAMATO Stoffoptik MT ALP Rau Alpaca
	MT RMK Rau Eiche Mokka	MT RMK Rau Eiche Mokka	MT RMK Rau Eiche Mokka TRAMATO Stoffoptik MT ALP Rau Alpaca
	MT ALP Rau Alpaca	MT ALP Rau Alpaca	MT ALP Rau Alpaca
	MT OBR Rau Oxid brüniert	MT OBR Rau Oxid brüniert	MT OBR Rau Oxid brüniert TRAMATO Stoffoptik MT ALP Rau Alpaca
			MT OC BG
	MT OC BG Rau matt Gipsweiß	MT OC BG Rau matt Gipsweiß	
	MT OC MA Rau matt Mergel	MT OC MA Rau matt Mergel	
	OC Matt lackiert	OC Matt lackiert	TRAMATO Stoffoptik MT ALP Rau Alpaca
	PA Offenporig lackiert	PA Offenporig lackiert	
	OCM Metallic-Lackierung	OCM Metallic-Lackierung	
	LC glänzend lackiert	LC glänzend lackiert	

ÜBERSICHT DER SEITENWÄNDE FÜR ZUSAMMENSTELLUNGEN MIT STRUKTUR **SMART**

Türtyp	Türausführung	Außenausführung Seitenwände	Innenausführung Seitenwände
	Best seller OC BG Best seller matt Gipsweiß	MT OC BG Rau matt Gipsweiß	TRAMATO Stoffoptik MT ALP Rau Alpaca
	Best seller OC MP Best seller matt Perlmutter	MT OC MP Rau matt Perlmutter	
	Best seller PA BG Best seller offenporig Gipsweiß	MT PA BG Rau offenporig Gipsweiß	
	Best seller PA MP Best seller offenporig Perlmutter	MT PA MP Rau offenporig Perlmutter	

ÜBERSICHT DER SEITENWÄNDE FÜR SPEZIALTÜREN

	Türtyp	Außenausführung Seitenwände	Innenausführung Seitenwände
DREHTÜREN	Profilo Specchio / Vetro	OC Matt lackiert	TRAMATO Stoffoptik MT ALP Rau Alpaca
		PA Offenporig lackiert	
	Gola vetro lucido	OC Matt lackiert	
SCHIEBETÜREN	Gola specchio	OC Matt lackiert	

MODULÜBERSICHT SCHRANK MIT DREHTÜR - SMART

HÖHEN

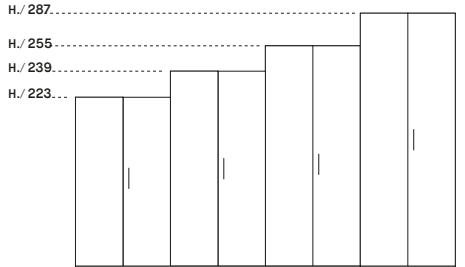

Tatsächliche Höhe einschließlich der FüÙe:
 - für Modul 223 Gesamthöhe H. 223,5 cm
 - für Modul 239 Gesamthöhe H. 239,5 cm
 - für Modul 255 Gesamthöhe H. 255,5 cm
 - für Modul 287 Gesamthöhe H. 287,5 cm

BREITEN UND TIEFEN

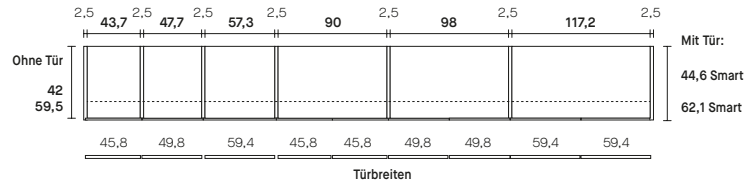

Toleranzgrenzen für die Montage: seitlich + 4 cm, Höhe + 3 cm

Drehtüren serienmäßig mit „Soft-Close-Scharnieren“

MODULÜBERSICHT

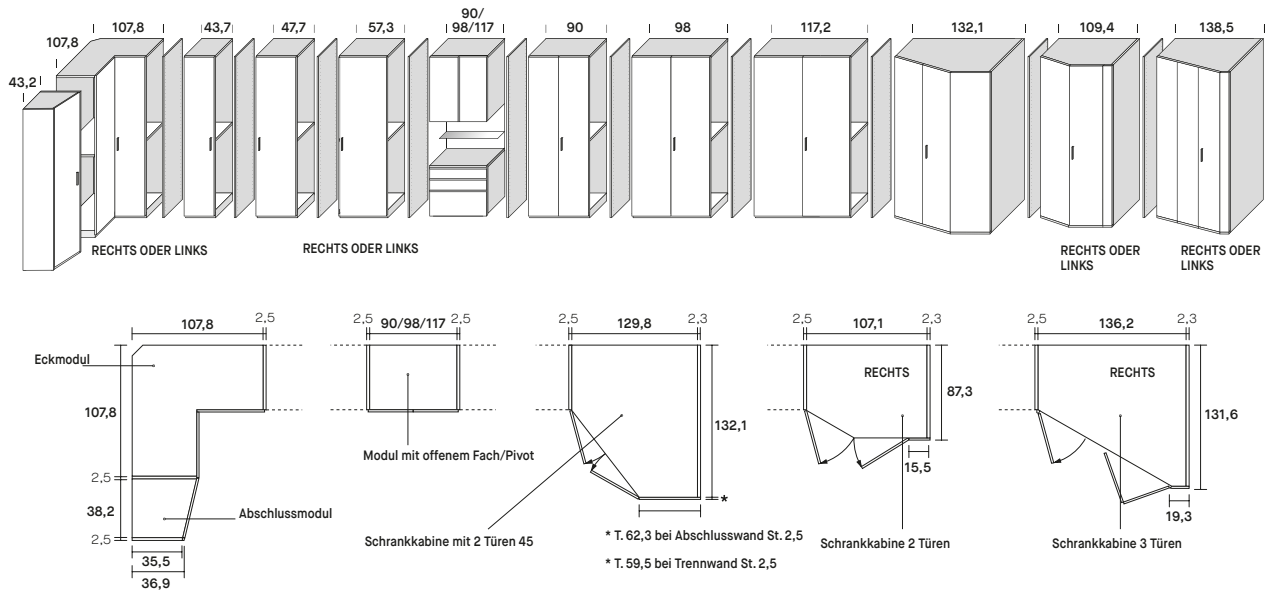

SPEZIELLE TRENNWAND

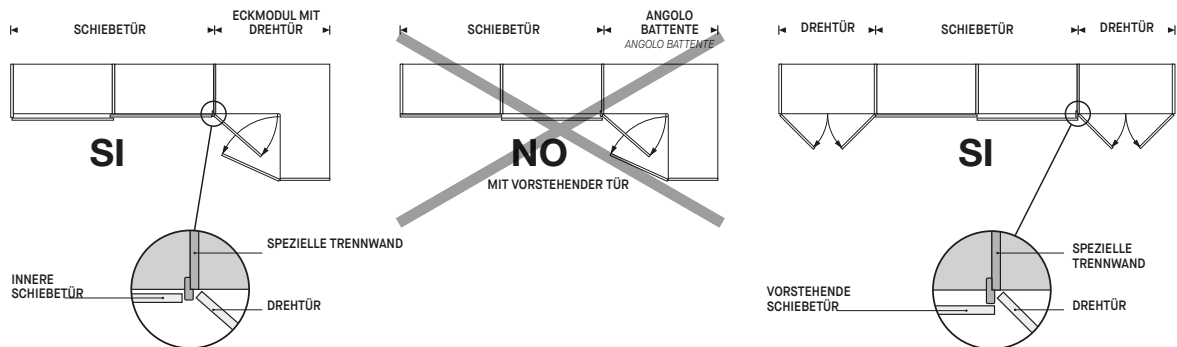

ZUSAMMENSTELLUNGEN DER PREISLISTE SCHRANK MIT **DREHTÜR - SMART**

Die seitlich angeführten Maße beinhalten den Raumbedarf der Seitenwände und Trennwände

* Nicht mit Tür Dandy erhältlich

		DORIS	GOLA
	H.		
	223	•	
	239	•	
	255	•	
	287	•	
B. 141,2 cm	Seite	18	
<input type="text" value="90"/> <input type="text" value="43,7"/>			
B. 153,2 cm	Seite	19	
<input type="text" value="98"/> <input type="text" value="47,7"/>			
B. 182 cm	Seite	19	
<input type="text" value="117,2"/> <input type="text" value="57,3"/>			
B. 187,5 cm	Seite	19	
<input type="text" value="90"/> <input type="text" value="90"/>			
B. 203,5 cm	Seite	19	
<input type="text" value="98"/> <input type="text" value="98"/>			
B. 233,7 cm	Seite	20	
<input type="text" value="90"/> <input type="text" value="90"/> <input type="text" value="43,7"/>			
B. 241,9 cm	Seite	21	
<input type="text" value="117,2"/> <input type="text" value="117,2"/>			
B. 253,7 cm	Seite	21	
<input type="text" value="98"/> <input type="text" value="98"/> <input type="text" value="47,7"/>			
B. 280 cm	Seite	21	
<input type="text" value="90"/> <input type="text" value="90"/> <input type="text" value="90"/>			
B. 301,7 cm	Seite	21	
<input type="text" value="117,2"/> <input type="text" value="117,2"/> <input type="text" value="57,3"/>			
B. 304 cm	Seite	22	
<input type="text" value="98"/> <input type="text" value="98"/> <input type="text" value="98"/>			
B. 361,6 cm	Seite	23	
<input type="text" value="117,2"/> <input type="text" value="117,2"/> <input type="text" value="117,2"/>			
B. 372,5 cm	Seite	23	
<input type="text" value="90"/> <input type="text" value="90"/> <input type="text" value="90"/> <input type="text" value="90"/>			
B. 404,5 cm	Seite	23	
<input type="text" value="98"/> <input type="text" value="98"/> <input type="text" value="98"/> <input type="text" value="98"/>			
B. 481,3 cm	Seite	23	
<input type="text" value="117,2"/> <input type="text" value="117,2"/> <input type="text" value="117,2"/> <input type="text" value="117,2"/>			

Jedes Modul ist serienmäßig mit 2 Kleiderstangen und einem inneren Einlegeboden ausgestattet (obligatorisch und fest).

ANM.: Für die Module nach Zentimetermaß T. 42 ist nur der innere Einlegeboden serienmäßig (obligatorisch und fest).

Ausziehbare Kleiderstange als Extra erhältlich COD 309921 € +115

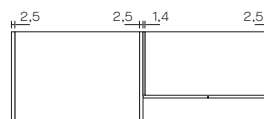

Für einen Tiefenwechsel im Falle eines angebauten Moduls ist eine Ausgleichs-Trennwand St. 1,4 erhältlich.
ANM.: Nicht für Tür Metropolis erhältlich. Preis wie Seitenwände St. 2,5

MODULÜBERSICHT SCHRANK MIT **SCHIEBETÜR SMART**

HÖHEN

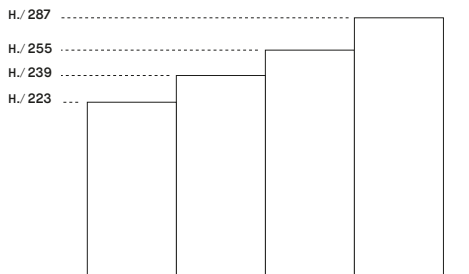

Tatsächliche Höhe inklusive Staubschutzbeschlägen:
 - für Modul 223 Gesamthöhe H. 225,5 cm
 - für Modul 239 Gesamthöhe H. 241,5 cm
 - für Modul 255 Gesamthöhe H. 257,5 cm
 - für Modul 287 Gesamthöhe H. 289,5 cm

Toleranzgrenzen für die Montage:
 seitlich + 4 cm, Höhe + 5 cm ab Seitenwand



Schiebetüren serienmäßig mit "Soft-Close-Schließmechanismen"

MODULÜBERSICHT

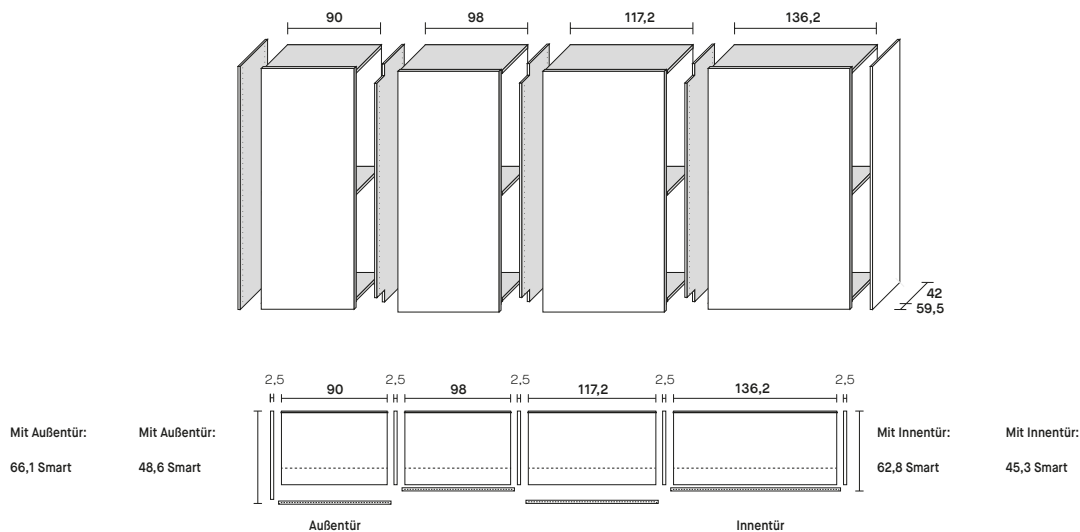

SPEZIELLE TRENNWAND

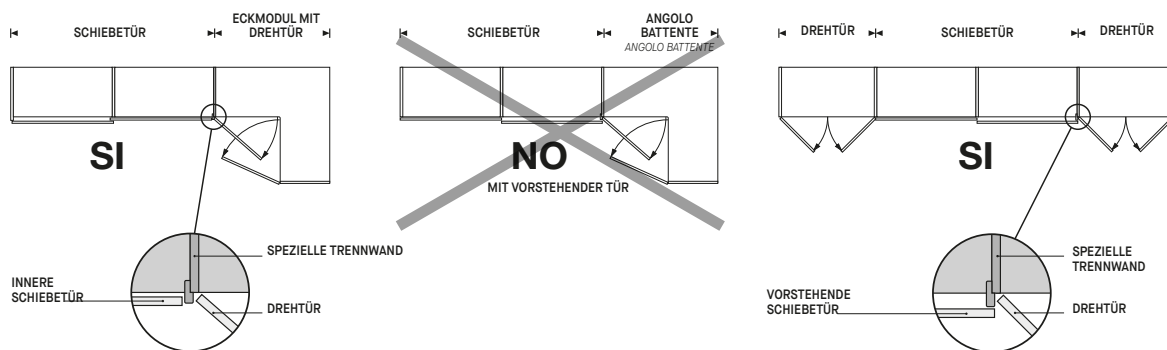







Typen- und Preisliste

ZUSAMMENSTELLUNGEN DER PREISLISTE SCHRANK MIT **SCHIEBETÜR SMART**

Die seitlich angeführten Maße beinhalten den Raumbedarf der Seitenwände und Trennwände

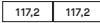
* Nicht mit Tür Remix erhältlich

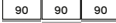
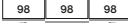
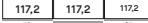
** Nicht mit Tür Kross erhältlich

	H.	ATHENA GOLA	DORIS / DORIS 2 SETTORI
	223	•	•
	239	•	•
	255	•	•
	287		•
B. 187,5 cm	Seite	28	34
			
B. 203,5 cm	Seite	29	35
			
B. 241,9 cm	Seite	29	35
			
B. 279,9 cm	Seite	29	35
			
B. 280 cm	Seite	29	35
			
B. 304 cm	Seite	29	36
			
B. 361,6 cm	Seite	31	37
			
B. 372,5 cm	Seite	31	37
			
B. 404,5 cm	Seite	31	37
			

Jedes Modul ist serienmäßig mit 2 Kleiderstangen und einem inneren Einlegeboden ausgestattet (obligatorisch und fest). ANM.: Für die Module nach Zentimetermaß T. 42 ist nur der innere Einlegeboden serienmäßig (obligatorisch und fest). Ausziehbare Kleiderstange als Extra erhältlich COD 309921

€ +115

SCHRANKKABINE

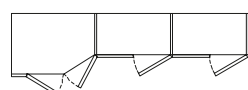
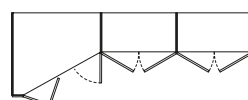
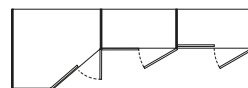

REGELN FÜR SCHRÄNKE MIT KOMBINIERTEN TÜRSYSTEMEN **SMART**

SCHRANK MIT KOMBINIERTEN SCHIEBETÜREN / DREHTÜREN

Wenn nach einer Schiebetür LISCIA oder LISCIA 2 **A** ein Eckmodul oder eine Schrankkabine angefügt werden soll, dann kann ausschließlich der Griff CLIP oder das eingebaute Griffprofil verwendet werden.

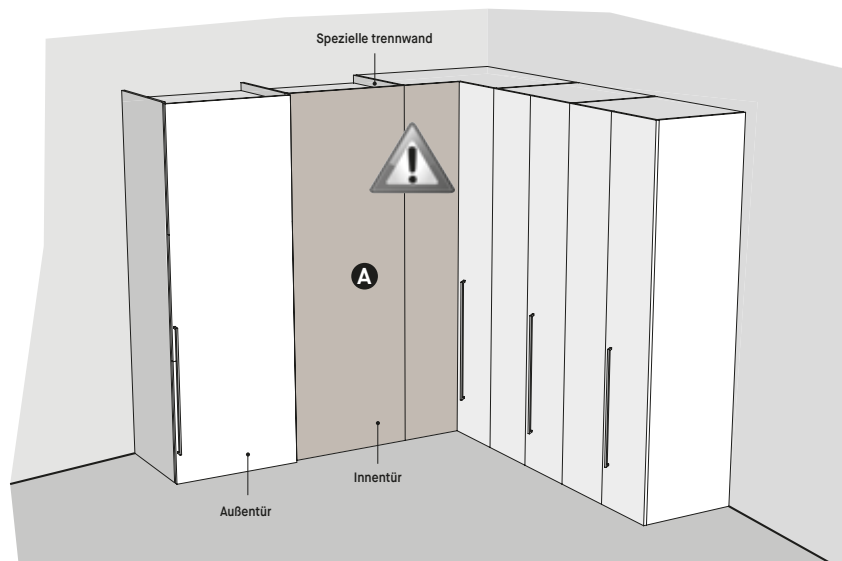

Regeln für Türen: LISCIA / LISCIA 2 SETTORI

LÖSUNGSBEISPIELE FÜR SPEZIELLE ECKVERBAUTEN

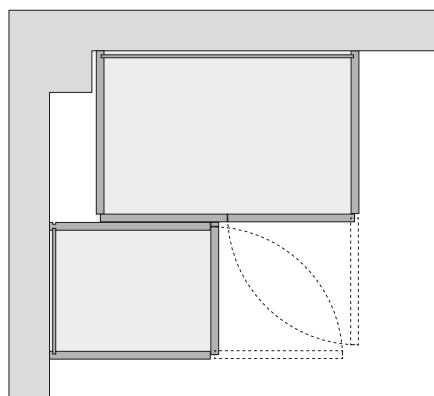

NEBENEINANDERSTELLEN VON 2 SERIENMÄSSIGEN ELEMENTEN

MODULE MIT DREHTÜREN **DORIS - GOLA**

MT Ausführungen Rau

CNV Canvas	RSB Eiche Sand
NAM Nussbaum Bernstein	RMK Eiche Mokka
YUT Yuta	RC Eiche Kohlegrau
LIN Leinen	RNC Astig hell
OC BG Matt Gipsweiß	RNN Astig Natur
OC MP Matt Perlmutt	CC Zement hell
OC ARN Matt Arena	CV Zement Cava
OC BA Matt Basaltgrau	CLC Kalk hell
OC MA Matt mergel	CLS Kalk dunkel
OC AN Matt Anthrazit	ALP Alpaca
PA BG Offenporig Gipsweiß	OBR Oxid brüniert
PA MP Offenporig Perlmutt	

OC Matt
PA Offenporig
LC Glänzend
OCM Metallic

* ANM.: Immer die Richtung der Tür angeben.

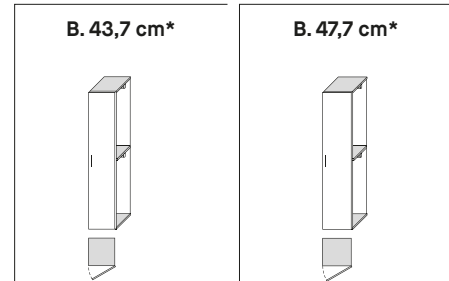

H.	Art.-Nr.	Art.-Nr.
223	300703 m² 0,09	300705 m² 0,10
239	300303 m² 0,10	300305 m² 0,11
255	300403 m² 0,11	300405 m² 0,12
287	300603 m² 0,13	300605 m² 0,14

Tür Profile Innenausführung des Moduls Türausführung

DORIS

	OC OCM	SMART TRAMATO MT ALP	SMART	MT CNV MT NAM	MT YUT MT LIN	527	563	552	592	
				MT OC (BG-MP-ARN-BA-MA-AN) MT PA (BG-MP) MT RSB MT RMK MT RC	MT CC MT CV MT CLC MT CLS MT RNC	MT RNN MT ALP MT OBR	595	647	624	679
				1/ONE OC (BG-MP-ARN-BA)		645	700	677	739	
				OC	PA	693	754	729	796	
				LC	OCM	876	1.013	932	1.086	



GOLA

	OC OCM	SMART TRAMATO MT ALP	SMART	MT CNV MT NAM	MT YUT MT LIN	481	578	504	601	
				MT OC (BG-MP-ARN-BA-MA-AN) MT PA (BG-MP) MT RSB MT RMK MT RC	MT CC MT CV MT CLC MT CLS MT RNC	MT RNN MT ALP MT OBR	510	588	539	616
				1/ONE OC (BG-MP-ARN-BA)		559	649	592	684	
				OC	PA	607	708	646	752	
				LC	OCM	863	994	921	1.063	

Für Beleuchtung siehe Seite 238

		B. 43,7 cm		B. 47,7 cm		
		DORIS	GOLA SMART	DORIS	GOLA SMART	
	AUFPREIS					
	SCHRANK PRO CM	BREITENZUSCHNITT	+ 81	+ 81	+ 81	+ 81
		HÖHENZUSCHNITT	+ 32	+ 49	+ 32	+ 49
TIEFENZUSCHNITT		+ 49	+ 49	+ 49	+ 49	

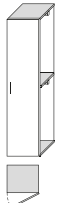
14 Für lackierte Innenausführung siehe Seite 220-221

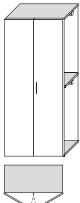
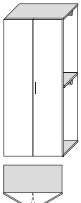
B. 57,3 cm*		B. 90 cm		B. 98 cm		B. 117,2 cm	
							
Art.-Nr.		Art.-Nr.		Art.-Nr.		Art.-Nr.	
300707 m² 0,12		310711 m² 0,17		310714 m² 0,17		310718 m² 0,25	
300307 m² 0,13		310311 m² 0,21		310314 m² 0,21		310318 m² 0,27	
300407 m² 0,14		310411 m² 0,25		310414 m² 0,25		310418 m² 0,29	
	300607 m² 0,16		310611 m² 0,27		310614 m² 0,28		310618 m² 0,33
611	657	786	858	812	886	918	1.006
684	743	868	976	905	1.019	1.023	1.128
746	814	965	1.093	1.008	1.158	1.155	1.281
809	885	1.060	1.213	1.110	1.295	1.286	1.432
1.053	1.242	1.504	1.779	1.595	1.900	1.829	2.205
559	663	741	872	765	896	866	1.012
593	689	784	917	820	956	932	1.074
659	767	897	1.014	940	1.060	1.065	1.220
725	845	973	1.168	1.026	1.250	1.202	1.392
1.055	1.254	1.488	1.760	1.584	1.878	1.830	2.217

Abschluss-Seitenwand St. 2,5 T. 59,5		
H.	Art.-Nr.	
223	314700 m² 0,056	
239	314300 m² 0,060	
255	314400 m² 0,064	
59,5 287		314600 m² 0,072
SMART Ausführung auf 2 Seiten		
MT: OC (BG-MP-ARN-BA-MA-AN) PA (BG-MP) / RSB / RMK RC / RNC / RNN / CC / CV CLC / CLS / ALP / OBR	128	128
SMART Ausführung Innenseite Stoffoptik / Alpaca		
MT: OC (BG-MP-ARN-BA-MA-AN) PA (BG-MP) / RSB / RMK RC / RNC / RNN / CC / CV CLC / CLS / ALP / OBR	128	128
OC / PA	210	274
LC / OCM	450	555

Trennwand St. 2,5 T. 59,5		
H.	Art.-Nr.	
223	314750 m² 0,056	
239	314350 m² 0,060	
255	314450 m² 0,064	
59,5 287		314650 m² 0,072
Stoffoptik / Alpaca		
	108	160

B. 57,3 cm		B. 90 cm		B. 98 cm		B. 117,2 cm	
DORIS	GOLA SMART	DORIS	GOLA SMART	DORIS	GOLA SMART	DORIS	GOLA SMART
+75	+75	+90	+90	+90	+90	+90	+90
+30	+45	+45	+60	+45	+60	+45	+60
+45	+45	+45	+45	+45	+45	+45	+45

Kürzung Seitenwand und Trennwand		
		-
		+16
		+16

MODULE MIT DREHTÜREN **DORIS - GOLA**

MT Ausführungen Rau

CNV	Canvas	RSB	Eiche Sand
NAM	Nussbaum Bernstein	RMK	Eiche Mokka
YUT	Yuta	RC	Eiche Kohlegrau
LIN	Leinen	RNC	Astig hell
OC BG	Matt Gipsweiß	RNN	Astig Natur
OC MP	Matt Perlmutt	CC	Zement hell
OC ARN	Matt Arena	CV	Zement Cava
OC BA	Matt Basaltgrau	CLC	Kalk hell
OC MA	Matt mergel	CLS	Kalk dunkel
OC AN	Matt Anthrazit	ALP	Alpaca
PA BG	Offenporig Gipsweiß	OBR	Oxid brüniert
PA MP	Offenporig Perlmutt		
<hr/>			
1/ONE OC BG	Matt Gipsweiß	OC	Matt
1/ONE OC MP	Matt Perlmutt	PA	Offenporig
1/ONE OC ARN	Matt Arena	LC	Glänzend
1/ONE OC BA	Matt Basaltgrau	OCM	Metallic

* ANM.: Immer die Richtung der Tür angeben.

B. 107,8 x 107,8 cm

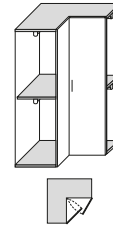

B. 43,2 cm*

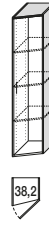

Komplett mit Seitenwand und Trennwand sowie 3 inneren Einlegeböden

H.	Art.-Nr.	Art.-Nr.
223	300723 m² 0,43	300725 m² 0,24
239	300323 m³ 0,45	300325 m³ 0,26
255	300423 m³ 0,47	300425 m³ 0,28
287	300623 m² 0,54	300625 m² 0,32

Tür	Profile	Innenausführung des Moduls	Türausführung	H.	Art.-Nr.	Art.-Nr.	Art.-Nr.	Art.-Nr.						
DORIS	OC OCM	SMART TRAMATO MT ALP	SMART	MT CNV MT NAM	MT YUT MT LIN		1.408	1.509	1.047	1.190				
				MT OC (BG-MP-ARN-BA-MA-AN) MT PA (BG-MP)	MT CC MT CV	MT RNN MT ALP MT OBR	1.490	1.627	1.158	1.321				
				MT RSB MT RMK MT RC	MT CLC MT CLS MT RNC									
				1/ONE OC (BG-MP-ARN-BA)			1.587	1.745	1.290	1.472				
				OC	PA		1.682	1.865	1.339	1.526				
				LC	OCM		2.224	2.536	1.762	2.067				
				GOLA	OC OCM	SMART TRAMATO MT ALP	SMART	MT CNV MT NAM	MT YUT MT LIN		1.363	1.461	1.002	1.142
								MT OC (BG-MP-ARN-BA-MA-AN) MT PA (BG-MP)	MT CC MT CV	MT RNN MT ALP MT OBR	1.406	1.568	1.074	1.262
								MT RSB MT RMK MT RC	MT CLC MT CLS MT RNC					
								1/ONE OC (BG-MP-ARN-BA)			1.518	1.666	1.123	1.323
OC	PA		1.595					1.819	1.252	1.481				
LC	OCM		2.207					2.517	1.746	2.047				

Für Beleuchtung siehe Seite 238

0 1 2 3	Die Module, Seitenwände und Trennwände sind auch in T. 42 cm erhältlich (ausgenommen Abschlusselement), ohne Aufpreis. Eckmodul T. 42 - B. 90,3 x 90,3 cm	B. 107,8 x 107,8 cm		B. 43,2 cm		
		DORIS	GOLA SMART	DORIS	GOLA SMART	
		AUFPREIS				
	SCHRANK PRO CM	BREITENZUSCHNITT	+ 97	+ 97	-	-
		HÖHENZUSCHNITT	+65	+ 97	+65	+ 81
		TIEFENZUSCHNITT	-	-	+ 114	+ 114

16 Für lackierte Innenausführung siehe Seite 220-221

B. 87,3 x 109,4 cm		B. 132 x 132 cm		B. 131,6 x 138,5 cm		Abschluss-Seitenwand St. 2,5 T. 59,5																	
						<table border="1"> <thead> <tr> <th>H.</th> <th colspan="2">Art.-Nr.</th> </tr> </thead> <tbody> <tr> <td>223</td> <td>314700</td> <td>m² 0,056</td> </tr> <tr> <td>239</td> <td>314300</td> <td>m² 0,060</td> </tr> <tr> <td>255</td> <td>314400</td> <td>m² 0,064</td> </tr> <tr> <td>287</td> <td colspan="2">314600 m² 0,072</td> </tr> </tbody> </table>			H.	Art.-Nr.		223	314700	m² 0,056	239	314300	m² 0,060	255	314400	m² 0,064	287	314600 m² 0,072	
H.	Art.-Nr.																						
223	314700	m² 0,056																					
239	314300	m² 0,060																					
255	314400	m² 0,064																					
287	314600 m² 0,072																						
Artikelnummer LINKS		Artikelnummer RECHTS		Art.-Nr.		SMART Ausführung auf 2 Seiten																	
311301S m² 0,49		311301D m² 0,49		311302 m² 0,62		MT: OC (BG-MP-ARN-BA-MA-AN) PA (BG-MP) / RSB / RMK 128 128																	
311401S m² 0,51		311401D m² 0,51		311402 m² 0,73		RC / RNC / RNN / CC / CV CLC / CLS / ALP / OBR																	
1.780		1.904				SMART Ausführung Innenseite Stoffoptik / Alpaca																	
1.873		1.999				MT: OC (BG-MP-ARN-BA-MA-AN) PA (BG-MP) / RSB / RMK 128 128																	
1.976		2.099				RC / RNC / RNN / CC / CV CLC / CLS / ALP / OBR																	
2.078		2.201				OC / PA 210 274																	
2.731		2.687				LC / OCM 450 555																	
1.733		1.856		2.440																			
1.788		1.911		2.497																			
1.908		2.031		2.669																			
1.994		2.118		2.780																			
2.720		2.676		3.724																			
						Trennwand St. 2,5 T. 59,5																	
						<table border="1"> <thead> <tr> <th>H.</th> <th colspan="2">Art.-Nr.</th> </tr> </thead> <tbody> <tr> <td>223</td> <td>314750</td> <td>m² 0,056</td> </tr> <tr> <td>239</td> <td>314350</td> <td>m² 0,060</td> </tr> <tr> <td>255</td> <td>314450</td> <td>m² 0,064</td> </tr> <tr> <td>287</td> <td colspan="2">314650 m² 0,072</td> </tr> </tbody> </table>			H.	Art.-Nr.		223	314750	m² 0,056	239	314350	m² 0,060	255	314450	m² 0,064	287	314650 m² 0,072	
H.	Art.-Nr.																						
223	314750	m² 0,056																					
239	314350	m² 0,060																					
255	314450	m² 0,064																					
287	314650 m² 0,072																						
						Stoffoptik / Alpaca 108 160																	
B. 87,3 x 109,4 cm		B. 132 x 132 cm		B. 131,6 x 138,5 cm		Kürzung Seitenwand und Trennwand																	
DORIS GOLA SMART		DORIS GOLA SMART		GOLA SMART																			
-		-		-		-																	
+65 +97		+97 + 114		+ 146		+16																	
-		-		-		+16																	

ZUSAMMENSTELLUNGEN MIT DREHTÜR **DORIS - GOLA**

MT Ausführungen Rau

CNV Canvas	RSB Eiche Sand
NAM Nussbaum Bernstein	RMK Eiche Mokka
YUT Yuta	RC Eiche Kohlegrau
LIN Leinen	RNC Astig hell
OC BG Matt Gipsweiß	RNN Astig Natur
OC MP Matt Perlmutt	CC Zement hell
OC ARN Matt Arena	CV Zement Cava
OC BA Matt Basaltgrau	CLC Kalk hell
OC MA Matt mergel	CLS Kalk dunkel
OC AN Matt Anthrazit	ALP Alpaca
PA BG Offenporig Gipsweiß	OBR Oxid brüniert
PA MP Offenporig Perlmutt	

1/ONE OC BG Matt Gipsweiß	OC Matt
1/ONE OC MP Matt Perlmutt	PA Offenporig
1/ONE OC ARN Matt Arena	LC Glänzend
1/ONE OC BA Matt Basaltgrau	OCM Metallic

B. 141,2 cm



H.	Art.-Nr.	
223	312713 m³ 0,48	
239	312313 m³ 0,49	
255	312413 m³ 0,50	
287		312613 m³ 0,51

Tür Profile Innenausführung des Moduls Türausführung

DORIS



OC
OCM

SMART

TRAMATO
MT ALP

SMART

MT CNV	MT YUT	
MT NAM	MT LIN	
MT OC (BG-MP-ARN-BA-MA-AN)	MT CC	MT RNN
MT PA (BG-MP)	MT CV	MT ALP
MT RSB	MT CLC	MT OBR
MT RMK	MT CLS	
MT RC	MT RNC	
1/ONE OC (BG-MP-ARN-BA)		
OC	PA	
LC	OCM	

1.610	1.838
1.827	2.134
1.973	2.305
2.281	2.676
3.389	4.063

GOLA



OC
OCM

SMART

TRAMATO
MT ALP

SMART

MT CNV	MT YUT	
MT NAM	MT LIN	
MT OC (BG-MP-ARN-BA-MA-AN)	MT CC	MT RNN
MT PA (BG-MP)	MT CV	MT ALP
MT RSB	MT CLC	MT OBR
MT RMK	MT CLS	
MT RC	MT RNC	
1/ONE OC (BG-MP-ARN-BA)		
OC	PA	
LC	OCM	

1.658	1.866
1.819	2.017
2.108	2.175
2.108	2.585
3.356	4.024

Für Beleuchtung siehe Seite 238

Die Zusammenstellungen sind auch in T. 42 cm erhältlich, ohne Aufpreis.

AUFPREIS		B. 141,2 cm	
		DORIS	GOLA SMART
SCHRANK PRO CM	BREITENZUSCHNITT	+ 178	+ 178
	HÖHENZUSCHNITT	+ 130	+ 162
	TIEFENZUSCHNITT	+ 146	+ 146

18 Für lackierte Innenausführung siehe Seite 220-221

B. 153,2 cm		B. 182 cm		B. 187,5 cm		B. 203,5 cm	
Art.-Nr.		Art.-Nr.		Art.-Nr.		Art.-Nr.	
312715 m² 0,49		312717 m² 0,54		312719 m² 0,55		312721 m² 0,55	
312315 m² 0,50		312317 m² 0,58		312319 m² 0,60		312321 m² 0,60	
312415 m² 0,56		312417 m² 0,62		312419 m² 0,65		312421 m² 0,65	
	312615 m² 0,62		312617 m² 0,64		312619 m² 0,76		312621 m² 0,78
1.641	1.894	1.806	2.079	1.850	2.132	2.174	2.188
1.893	2.210	2.070	2.383	2.100	2.463	2.747	2.549
2.048	2.409	2.265	2.607	2.293	2.698	2.379	2.828
2.366	2.799	2.623	3.025	2.648	3.135	2.747	3.298
3.536	4.257	3.890	4.718	4.017	4.829	4.199	4.945
1.546	1.913	1.702	2.092	1.759	2.160	1.806	2.207
1.722	2.084	1.888	2.275	1.932	2.346	2.003	2.424
1.895	2.255	2.087	2.498	2.157	2.541	2.243	2.631
2.200	2.710	2.454	2.945	2.475	3.045	2.581	3.209
3.514	4.212	3.893	4.742	3.984	4.790	4.177	5.026

B. 153,2 cm		B. 182 cm		B. 187,5 cm		B. 203,5 cm	
DORIS	GOLA SMART	DORIS	GOLA SMART	DORIS	GOLA SMART	DORIS	GOLA SMART
+ 178	+ 178	+ 178	+ 178	+ 195	+ 195	+ 195	+ 195
+ 130	+ 162	+ 130	+ 162	+ 146	+ 178	+ 146	+ 178
+ 146	+ 146	+ 146	+ 146	+ 146	+ 146	+ 146	+ 146

ZUSAMMENSTELLUNGEN MIT DREHTÜR **DORIS - GOLA**

MT Ausführungen Rau

CNV Canvas	RSB Eiche Sand
NAM Nussbaum Bernstein	RMK Eiche Mokka
YUT Yuta	RC Eiche Kohlegrau
LIN Leinen	RNC Astig hell
OC BG Matt Gipsweiß	RNN Astig Natur
OC MP Matt Perlmutt	CC Zement hell
OC ARN Matt Arena	CV Zement Cava
OC BA Matt Basaltgrau	CLC Kalk hell
OC MA Matt mergel	CLS Kalk dunkel
OC AN Matt Anthrazit	ALP Alpaca
PA BG Offenporig Gipsweiß	OBR Oxid brüniert
PA MP Offenporig Perlmutt	
<hr/>	
1/ONE OC BG Matt Gipsweiß	OC Matt
1/ONE OC MP Matt Perlmutt	PA Offenporig
1/ONE OC ARN Matt Arena	LC Glänzend
1/ONE OC BA Matt Basaltgrau	OCM Metallic

B. 233,7 cm

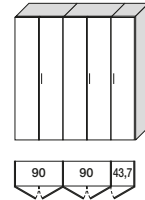

H.	Art.-Nr.	
223	312723	m ² 0,71
239	312323	m ² 0,76
255	312423	m ² 0,83
287	312623	m ² 0,90

Tür Profile Innenausführung des Moduls Türausführung

DORIS

	OC OCM	SMART TRAMATO MT ALP	SMART	MT CNV MT NAM	MT YUT MT LIN		2.484	2.856
				MT OC (BG-MP-ARN-BA-MA-AN) MT PA (BG-MP)	MT CC MT CV MT CLC MT CLS MT RNC	MT RNN MT ALP MT OBR	2.803	3.271
				MT RSB MT RMK MT RC				
				1/ONE OC (BG-MP-ARN-BA)			3.046	3.559
				OC	PA		3.449	4.050
				LC	OCM		5.001	6.004

GOLA

	OC OCM	SMART TRAMATO MT ALP	SMART	MT CNV MT NAM	MT YUT MT LIN		2.348	2.899
				MT OC (BG-MP-ARN-BA-MA-AN) MT PA (BG-MP)	MT CC MT CV MT CLC MT CLS MT RNC	MT RNN MT ALP MT OBR	2.550	3.095
				MT RSB MT RMK MT RC				
				1/ONE OC (BG-MP-ARN-BA)			2.824	3.351
				OC	PA		3.190	3.914
				LC	OCM		4.952	5.945

Für Beleuchtung siehe Seite 238

		B. 233,7 cm	
AUFPREIS		DORIS	GOLA SMART
0 1 2 3 	Die Zusammenstellungen sind auch in T. 42 cm erhältlich, ohne Aufpreis. SCHRANK PRO CM	BREITENZUSCHNITT	+ 276
		HÖHENZUSCHNITT	+ 195
		TIEFENZUSCHNITT	+ 211

20 Für lackierte Innenausführung siehe Seite 220-221

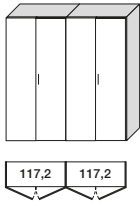
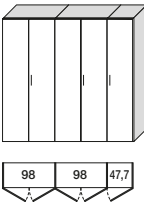
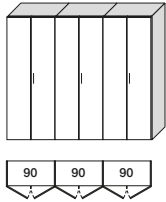
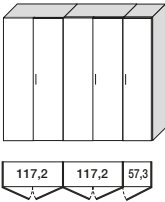
B. 241,9 cm		B. 253,7 cm		B. 280 cm		B. 301,7 cm	
							
Art.-Nr.		Art.-Nr.		Art.-Nr.		Art.-Nr.	
312725 m² 0,67		312727 m² 0,73		312729 m² 0,81		312731 m² 0,83	
312325 m² 0,72 / ft³ 26		312327 m² 0,77		312329 m² 0,87		312331 m² 0,91	
312425 m² 0,77		312427 m² 0,88		312429 m² 0,95		312431 m² 0,98	
	312625 m² 0,82		312627 m² 0,99		312629 m² 1,10		312631 m² 1,05
2.113	2.428	2.561	2.941	2.744	3.151	2.833	3.246
2.410	2.768	2.906	3.390	3.077	3.599	3.201	3.672
2.674	3.073	3.165	3.728	3.366	3.953	3.528	4.048
3.100	3.572	3.584	4.255	3.816	4.510	4.017	4.618
4.666	5.681	5.239	6.318	5.629	6.769	5.827	7.084
2.010	2.441	2.418	2.970	2.608	3.193	2.677	3.265
2.228	2.660	2.650	3.201	2.824	3.424	2.929	3.510
2.494	2.952	2.943	3.476	3.161	3.716	3.261	3.880
2.931	3.492	3.334	4.122	3.556	4.374	3.764	4.498
4.668	5.705	5.207	6.250	5.581	6.711	5.831	7.120

B. 241,9 cm		B. 253,7 cm		B. 280 cm		B. 301,7 cm	
DORIS	GOLA SMART	DORIS	GOLA SMART	DORIS	GOLA SMART	DORIS	GOLA SMART
+ 195	+ 195	+ 276	+ 276	+ 292	+ 292	+ 276	+ 276
+ 146	+ 178	+ 195	+ 243	+ 211	+ 260	+ 195	+ 243
+ 146	+ 146	+ 211	+ 211	+ 211	+ 211	+ 211	+ 211

ZUSAMMENSTELLUNGEN MIT DREHTÜR DORIS - GOLA

MT Ausführungen Rau

CNV Canvas	RSB Eiche Sand
NAM Nussbaum Bernstein	RMK Eiche Mokka
YUT Yuta	RC Eiche Kohlegrau
LIN Leinen	RNC Astig hell
OC BG Matt Gipsweiß	RNN Astig Natur
OC MP Matt Perlmutt	CC Zement hell
OC ARN Matt Arena	CV Zement Cava
OC BA Matt Basaltgrau	CLC Kalk hell
OC MA Matt mergel	CLS Kalk dunkel
OC AN Matt Anthrazit	ALP Alpaca
PA BG Offenporig Gipsweiß	OBR Oxid brüniert
PA MP Offenporig Perlmutt	

1/ONE OC BG Matt Gipsweiß	OC Matt
1/ONE OC MP Matt Perlmutt	PA Offenporig
1/ONE OC ARN Matt Arena	LC Glänzend
1/ONE OC BA Matt Basaltgrau	OCM Metallic

B. 304 cm	
H.	Art.-Nr.
223	312733 m³ 0,85
239	312333 m³ 0,87
255	312433 m³ 1,00
287	312633 m³ 1,13

Tür Profile Innenausführung des Moduls Türausführung

DORIS

	OC OCM	SMART TRAMATO MT ALP	SMART	MT CNV MT NAM	MT YUT MT LIN	2.822	3.235	
				MT OC (BG-MP-ARN-BA-MA-AN) MT PA (BG-MP)	MT CC MT CV MT CLC MT CLS MT RNC	MT RNN MT ALP MT OBR	3.187	3.729
				MT RSB MT RMK MT RC			3.496	4.148
				1/ONE OC (BG-MP-ARN-BA)			3.965	4.753
				OC	PA		5.902	7.133
				LC	OCM			

GOLA

	OC OCM	SMART TRAMATO MT ALP	SMART	MT CNV MT NAM	MT YUT MT LIN	2.679	3.264	
				MT OC (BG-MP-ARN-BA-MA-AN) MT PA (BG-MP)	MT CC MT CV MT CLC MT CLS MT RNC	MT RNN MT ALP MT OBR	2.931	3.541
				MT RSB MT RMK MT RC			3.291	3.852
				1/ONE OC (BG-MP-ARN-BA)			3.715	4.620
				OC	PA		5.870	7.065
				LC	OCM			

Für Beleuchtung siehe Seite 238

Die Zusammenstellungen sind auch in T. 42 cm erhältlich, ohne Aufpreis.		B. 304 cm
AUFPREIS		DORIS
SCHRANK PRO CM	BREITENZUSCHNITT	+ 292
	HÖHENZUSCHNITT	+ 211
	TIEFENZUSCHNITT	+ 211

22 Für lackierte Innenausführung siehe Seite 220-221

B. 361,6 cm		B. 372,5 cm		B. 404,5 cm		B. 481,3 cm	
Art.-Nr.		Art.-Nr.		Art.-Nr.		Art.-Nr.	
312739 m³ 1,02		312741 m³ 1,04		312743 m³ 1,04		312747 m³ 1,28	
312339 m³ 1,05		312341 m³ 1,14		312343 m³ 1,14		312347 m³ 1,38	
312439 m³ 1,13		312441 m³ 1,24		312443 m³ 1,32		312447 m³ 1,48	
	312639 m³ 1,21		312641 m³ 1,45		312643 m³ 1,50		312647 m³ 1,58
3.140	3.595	3.638	4.169	3.742	4.237	4.166	4.762
3.541	4.057	4.054	4.736	4.201	4.909	4.672	5.346
3.937	4.514	4.439	5.208	4.612	5.467	5.200	5.956
4.494	5.165	4.984	5.885	5.183	6.209	5.888	6.759
6.603	8.048	7.242	8.710	7.605	9.194	8.540	10.414
2.984	3.615	3.457	4.226	3.552	4.321	3.958	4.788
3.268	3.895	3.716	4.503	3.859	4.658	4.309	5.130
3.668	4.333	4.166	4.892	4.339	5.074	4.841	5.714
4.241	5.045	4.638	5.703	4.850	6.032	5.551	6.599
6.606	8.084	7.177	8.632	7.562	9.103	8.544	10.462

B. 361,6 cm		B. 372,5 cm		B. 404,5 cm		B. 481,3 cm	
DORIS	GOLA SMART	DORIS	GOLA SMART	DORIS	GOLA SMART	DORIS	GOLA SMART
+ 292	+ 292	+ 389	+ 389	+ 389	+ 389	+ 389	+ 389
+ 211	+ 260	+ 276	+ 341	+ 276	+ 341	+ 276	+ 341
+ 211	+ 211	+ 276	+ 276	+ 276	+ 276	+ 276	+ 276

OFFENES MODUL (DREHTÜR) T. 59,5

MT Ausführungen Rau

OC BG Matt Gipsweiß	RSB Eiche Sand
OC MP Matt Perlmutter	RMK Eiche Mokka
OC ARN Matt Arena	RC Eiche Kohlegrau
OC BA Matt Basaltgrau	RNC Astig hell
OC MA Matt mergel	RNN Astig Natur
OC AN Matt Anthrazit	CC Zement hell
PA BG Offenporig Gipsweiß	CV Zement Cava
PA MP Offenporig Perlmutter	CLC Kalk hell
	CLS Kalk dunkel
	OBR Oxid brüniert
	OC Matt
	PA Offenporig
	LC Glänzend
	OCM Metallic

Für Abteil
B. 90 / 98 / 117,2 cm

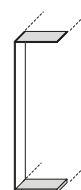

H.

Die Schublade wird in Ausführung der Struktur berechnet

* ANM.: H. 223 cm mit einem Einlegeboden weniger als auf der Zeichnung.
H. 287 mit einem Einlegeboden mehr als auf der Zeichnung.

** ANM.: H. 223 und 239 mit einem Einlegeboden weniger als auf der Zeichnung.

Die Artikelnummern der serienmäßigen Module heranziehen →

Innenausführung des Moduls			223	287	
VERSION 1					
	MT OC (BG-MP-ARN-BA-MA-AN) MT PA (BG-MP) MT RSB MT RMK MT RC	MT CC MT CV MT CLC MT CLS MT RNC	MT RNN MT OBR	512	560
	OC	PA		717	807
VERSION 2					
	MT OC (BG-MP-ARN-BA-MA-AN) MT PA (BG-MP) MT RSB MT RMK MT RC	MT CC MT CV MT CLC MT CLS MT RNC	MT ALP MT OBR	449	498
	OC	PA		676	767
VERSION 3					
	MT OC (BG-MP-ARN-BA-MA-AN) MT PA (BG-MP) MT RSB MT RMK MT RC	MT CC MT CV MT CLC MT CLS MT RNC	MT RNN MT OBR	321	370
	OC	PA		567	657
VERSION 4					
	MT OC (BG-MP-ARN-BA-MA-AN) MT PA (BG-MP) MT RSB MT RMK MT RC	MT CC MT CV MT CLC MT CLS MT RNC	MT RNN MT OBR	276	289
	OC	PA		476	507

Maße des offenen Abschlusselements in Kombination mit zugehörigem Modul mit Drehtür.

Zur Kalkulation eines Schrankes mit offenem Abschlussmodul ist der Preis des Moduls mit gewählter Drehtür (90-98-117,2) zu jenem der Seitenwand hinzuzurechnen und das zugehörige Abschlusselement hinzuzufügen. Als Alternative den Preis des gewählten Abschlusselements zu jenem der ausgewählten Zusammenstellung mit Drehtür hinzuzufügen.

Abschlusselement mit Modul B. 90

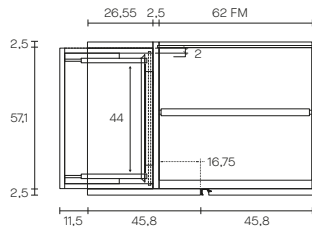

Abschlusselement mit Modul B. 98

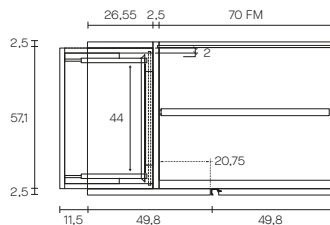

Abschlusselement mit Modul B. 117,2

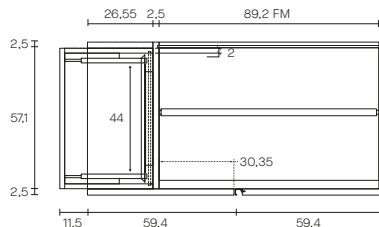

LED-Beleuchtung für Einlegeboden als Extra, Netzgerät nicht inklusive

Bei vorhandener Spiegelbeleuchtung nicht lieferbar.

€ + 36

LED-Beleuchtung für Spiegel Version 1 als Extra, Netzgerät nicht inklusive

€ + 151

LED-Beleuchtung für Spiegel Version 2 als Extra, Netzgerät nicht inklusive

€ + 125

Netzgerät obligatorisch

€ + 61

Abschluss-Seitenwand St. 2,5 T. 59,5

H.	Art.-Nr.
223	314700 m² 0,056
239	314300 m² 0,060
255	314400 m² 0,064
59,5 287	314600 m² 0,072

SMART
Ausführung auf 2 Seiten

MT:		
OC (BG-MP-ARN-BA-MA-AN)		
PA (BG-MP) / RSB / RMK	128	128
RC / RNC / RNN / CC / CV		
CLC / CLS / ALP / OBR		

SMART
Ausführung Innenseite Stoffoptik / Alpaca

MT:		
OC (BG-MP-ARN-BA-MA-AN)		
PA (BG-MP) / RSB / RMK	128	128
RC / RNC / RNN / CC / CV		
CLC / CLS / ALP / OBR		

OC / PA	210	274
LC / OCM	450	555

AUFPREIS
Schublade für offenes Abschlusselement



MT:	MT CNV	MT NAM	MT YUT	MT LIN	OC / PA
OC (BG-MP-ARN-BA-MA-AN) / PA (BG-MP) / RSB / RMK / RC / RNC / RNN / CC / CV / CLC / CLS / ALP / OBR	- 15				51

OC / PA - 66 - 51 -

Einlegeboden für offenes Abschlusselement



29 36 58

Trennwand St. 2,5 T. 59,5

H.	Art.-Nr.
223	314750 m² 0,056
239	314350 m² 0,060
255	314450 m² 0,064
59,5 287	314650 m² 0,072

Stoffoptik / Alpaca 108 160

MODULE MIT SCHIEBETÜR **ATHENA - GOLA**

MT Ausführungen Rau



CNV	Canvas	RSB	Eiche Sand
NAM	Nussbaum Bernstein	RMK	Eiche Mokka
YUT	Yuta	RC	Eiche Kohlegrau
LIN	Leinen	RNC	Astig hell
OC BG	Matt Gipsweiß	RNN	Astig Natur
OC MP	Matt Perlmutter	CC	Zement hell
OC ARN	Matt Arena	CV	Zement Cava
OC BA	Matt Basaltgrau	CLC	Kalk hell
OC MA	Matt mergel	CLS	Kalk dunkel
OC AN	Matt Anthrazit	ALP	Alpaca
PA BG	Offenporig Gipsweiß	OBR	Oxid brüniert
PA MP	Offenporig Perlmutter		

1/ONE OC BG	Matt Gipsweiß	OC	Matt
1/ONE OC MP	Matt Perlmutter	PA	Offenporig
1/ONE OC ARN	Matt Arena	LC	Glänzend
1/ONE OC BA	Matt Basaltgrau	OCM	Metallic

B. 90 cm



H.	Art.-Nr.
223	310731 m² 0,21
239	310331 m² 0,23
255	310431 m² 0,25

Tür	Griffeinsatz	Mittlere Platte	Innenausführung des Moduls	Türausführung			
ATHENA 	Ausführungen Rau OC PA Glänzendes Glas Grauer Spiegel	Ausführungen Rau (kein Geflecht) OC PA	SMART TRAMATO MT ALP	MT CNV MT NAM	MT YUT MT LIN	990	
				MT OC (BG-MP-ARN-BA-MA-AN) MT PA (BG-MP) MT RSB MT RMK MT RC	MT CC MT CV MT CLC MT CLS	MT RNC MT RNN MT ALP MT OBR	1.096
				1/ONE OC (BG-MP-ARN-BA)		1.269	
				OC	PA	1.444	
				Glänzendes Glas / Grauer Spiegel383 - Bronzeoptik 382- Silberoptik 381		1.374	
GOLA 	OC OCM	SMART TRAMATO MT ALP	SMART	MT CNV MT NAM	MT YUT MT LIN	1.020	
				MT OC (BG-MP-ARN-BA-MA-AN) MT PA (BG-MP) MT RSB MT RMK MT RC	MT CC MT CV MT CLC MT CLS	MT RNC MT RNN MT ALP MT OBR	1.074
				1/ONE OC (BG-MP-ARN-BA)		1.131	
				OC	PA	1.186	
				LC	OCM	1.730	
				Glänzendes Glas / Grauer Spiegel383 - Bronzeoptik 382- Silberoptik 381		1.374	

Für Beleuchtung
siehe Seite 238



Die Module, Seitenwände und Trennwände sind auch in T. 42 cm erhältlich, ohne Aufpreis.

GLASTÜREN KÖNNEN NICHT VERKLEINERT WERDEN

AUFPREIS

SCHRANK PRO CM

BREITENZUSCHNITT

HÖHENZUSCHNITT

TIEFENZUSCHNITT

B. 90 cm

ATHENA

GOLA
SMART

+ 243



+ 65

+ 49

+ 124

+ 65

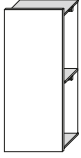
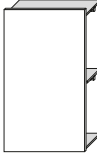
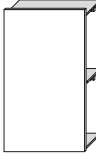
+ 49

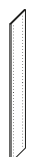
B. 98 cm		B. 117,2 cm		B. 136,2 cm		Abschluss-Seitenwand St. 2,5 T. 59,5/62,8/63,3	
							
Art.-Nr.		Art.-Nr.		Art.-Nr.		H.	
310734 m² 0,23		310738 m² 0,28		310741 m² 0,33		Art.-Nr.	
310334 m² 0,25		310338 m² 0,30		310341 m² 0,35		223 314701 m² 0,11	
310434 m² 0,27		310438 m² 0,32		310441 m² 0,37		239 314301 m² 0,11	
						255 314401 m² 0,11	
						SMART Ausführung auf 2 Seiten	
						MT: OC (BG-MP-ARN-BA-MA-AN) PA (BG-MP) / RSB / RMK 128 RC / RNC / RNN / CC / CV CLC / CLS / ALP / OBR	
1.040		1.167		1.353		SMART Ausführung Innenseite Stoffoptik / Alpaca	
1.142		1.284		1.489		MT: OC (BG-MP-ARN-BA-MA-AN) PA (BG-MP) / RSB / RMK 128 RC / RNC / RNN / CC / CV CLC / CLS / ALP / OBR	
1.330		1.511		1.749		OC / PA 210	
1.521		1.736		2.013		LC / OCM 450	
						Trennwand St. 2,5 T. 59,5	
1.052		1.169					
1.114		1.228				H.	
1.173		1.302				Art.-Nr.	
1.233		1.372				223 314751 m² 0,11	
1.806		2.071				239 314351 m² 0,11	
1.434		1.608				255 314451 m² 0,11	
						Stoffoptik / Alpaca 108	

B. 98 cm		B. 117,2 cm		B. 136,2 cm		Kürzung Seitenwand und Trennwand	
ATHENA	GOLA SMART	ATHENA	GOLA SMART	ATHENA			
+ 243	+ 124	+ 243	+ 124	+ 243		-	
+ 65	+ 65	+ 65	+ 65	+ 65		+16	
+ 45	+ 49	+ 45	+ 45	+ 45		+16	

ZUSAMMENSTELLUNGEN MIT SCHIEBETÜR ATHENA - GOLA



MT Ausführungen Rau

CNV Canvas	RSB Eiche Sand
NAM Nussbaum Bernstein	RMK Eiche Mokka
YUT Yuta	RC Eiche Kohlegrau
LIN Leinen	RNC Astig hell
OC BG Matt Gipsweiß	RNN Astig Natur
OC MP Matt Perlmutt	CC Zement hell
OC ARN Matt Arena	CV Zement Cava
OC BA Matt Basaltgrau	CLC Kalk hell
OC MA Matt mergel	CLS Kalk dunkel
OC AN Matt Anthrazit	ALP Alpaca
PA BG Offenporig Gipsweiß	OBR Oxid brüniert
PA MP Offenporig Perlmutt	
1/ONE OC BG Matt Gipsweiß	OC Matt
1/ONE OC MP Matt Perlmutt	PA Offenporig
1/ONE OC ARN Matt Arena	LC Glänzend
1/ONE OC BA Matt Basaltgrau	OCM Metallic

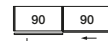
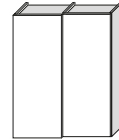
B. 187,5 cm



H.	Art.-Nr.
223	312761 m² 0,60
239	312361 m² 0,64
255	312461 m² 0,68

Tür	Griffeinsatz	Mittlere Platte	Innenausführung des Moduls	Türausführung			
ATHENA 	Ausführungen Rau OC PA Glänzendes Glas Grauer Spiegel	Ausführungen Rau (kein Geflecht) OC PA	SMART TRAMATO MT ALP	SMART MT CNV MT NAM MT OC (BG-MP-ARN-BA-MA-AN) MT PA (BG-MP) MT RSB MT RMK MT RC	MT YUT MT LIN MT CC MT CV MT CLC MT CLS	MT RNC MT RNN MT ALP MT OBR	2.256 2.555 2.901 3.416
				1/ONE OC (BG-MP-ARN-BA)			
				OC	PA		
GOLA 	OC OCM	SMART	SMART	MT CNV MT NAM MT OC (BG-MP-ARN-BA-MA-AN) MT PA (BG-MP) MT RSB MT RMK MT RC	MT YUT MT LIN MT CC MT CV MT CLC MT CLS	MT RNC MT RNN MT ALP MT OBR	2.317 2.511 2.626 2.901 4.469 3.275
				1/ONE OC (BG-MP-ARN-BA)			
				OC	PA		
				LC	OCM		
				Glänzendes Glas / Grauer Spiegel383 - Bronzeoptik 382- Silberoptik 381			

Für Beleuchtung siehe Seite 238



Die Zusammenstellungen sind auch in T. 42 cm erhältlich, ohne Aufpreis.

GLASTÜREN KÖNNEN NICHT VERKLEINERT WERDEN

AUFPREIS

SCHRANK PRO CM

BREITENZUSCHNITT

HÖHENZUSCHNITT

TIEFENZUSCHNITT

B. 187,5 cm

ATHENA

GOLA
SMART

+ 487

+ 249

+ 178

+ 178

+ 146

+ 146

28 Für lackierte Innenausführung siehe Seite 220-221

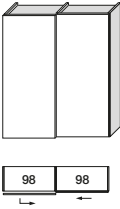
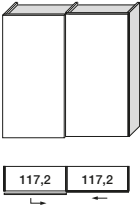
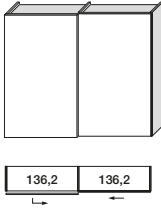
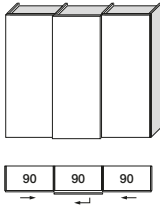
B. 203,5 cm		B. 241,9 cm		B. 279,9 cm		B. 280 cm	
							
Art.-Nr.		Art.-Nr.		Art.-Nr.		Art.-Nr.	
312762 m² 0,64		312763 m² 0,73		312764 m² 0,84		312766 m² 0,87	
312362 m² 0,68		312363 m² 0,78		312364 m² 0,88		312366 m² 0,93	
312462 m² 0,72		312463 m² 0,82		312464 m² 0,92		312466 m² 0,99	
2.358		2.611		2.983		3.354	
2.431		2.931		3.342		3.758	
3.024		3.385		3.861		4.278	
3.569		4.000		4.553		4.968	
2.382		2.615				3.445	
2.591		2.825				3.694	
2.710		2.968				3.865	
2.994		3.273				4.195	
4.620		5.150				6.308	
3.396		3.744				4.757	

B. 203,5 cm		B. 241,9 cm		B. 279,9 cm		B. 280 cm	
ATHENA	GOLA SMART	ATHENA	GOLA SMART	ATHENA	ATHENA	ATHENA	GOLA SMART
+ 487	+ 249	+ 487	+ 249	+ 487	+ 487	+ 730	+ 260
+ 178	+ 178	+ 178	+ 178	+ 211	+ 211	+ 260	+ 260
+ 146	+ 146	+ 146	+ 146	+ 146	+ 146	+ 211	+ 211

ZUSAMMENSTELLUNGEN MIT SCHIEBETÜR ATHENA - GOLA

MT Ausführungen Rau

CNV Canvas	RSB Eiche Sand
NAM Nussbaum Bernstein	RMK Eiche Mokka
YUT Yuta	RC Eiche Kohlegrau
LIN Leinen	RNC Astig hell
OC BG Matt Gipsweiß	RNN Astig Natur
OC MP Matt Perlmutter	CC Zement hell
OC ARN Matt Arena	CV Zement Cava
OC BA Matt Basaltgrau	CLC Kalk hell
OC MA Matt mergel	CLS Kalk dunkel
OC AN Matt Anthrazit	ALP Alpaca
PA BG Offenporig Gipsweiß	OBR Oxid brüniert
PA MP Offenporig Perlmutter	
1/ONE OC BG Matt Gipsweiß	OC Matt
1/ONE OC MP Matt Perlmutter	PA Offenporig
1/ONE OC ARN Matt Arena	LC Glänzend
1/ONE OC BA Matt Basaltgrau	OCM Metallic

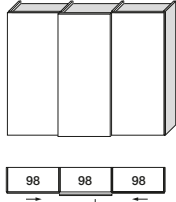
B. 304 cm	
	
H.	Art.-Nr.
223	312767 m² 0,93
239	312367 m² 0,99
255	312467 m² 1,05

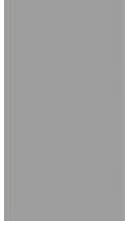
Tür	Griffeinsatz	Mittlere Platte	Innenausführung des Moduls	Türausführung			
ATHENA 	Ausführungen Rau OC PA Glänzendes Glas Grauer Spiegel	Ausführungen Rau (kein Geflecht) OC PA	SMART TRAMATO MT ALP	MT CNV MT NAM	MT YUT MT LIN	3.506	
				MT OC (BG-MP-ARN-BA-MA-AN) MT PA (BG-MP) MT RSB MT RMK MT RC	MT CC MT CV MT CLC MT CLS	MT RNC MT RNN MT ALP MT OBR	3.898
				OC	PA	5.198	
GOLA 	OC OCM	SMART	SMART	MT CNV MT NAM	MT YUT MT LIN	3.542	
				MT OC (BG-MP-ARN-BA-MA-AN) MT PA (BG-MP) MT RSB MT RMK MT RC	MT CC MT CV MT CLC MT CLS	MT RNC MT RNN MT ALP MT OBR	3.814
				1/ONE OC (BG-MP-ARN-BA)		3.992	
				OC	PA	4.335	
				LC	OCM	6.535	
				Glänzendes Glas / Grauer Spiegel 383 - Bronzeoptik 382 - Silberoptik 381			

Für Beleuchtung siehe Seite 238

Die Zusammenstellungen sind auch in T. 42 cm erhältlich, ohne Aufpreis.		B. 304 cm	
GLASTÜREN KÖNNEN NICHT VERKLEINERT WERDEN			
AUFPREIS		ATHENA	GOLA SMART
SCHRANK PRO CM	BREITENZUSCHNITT	+ 730	+ 373
	HÖHENZUSCHNITT	+ 260	+ 260
	TIEFENZUSCHNITT	+ 211	+ 211

30 Für lackierte Innenausführung siehe Seite 220-221

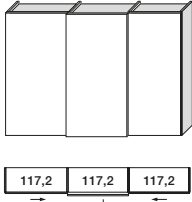
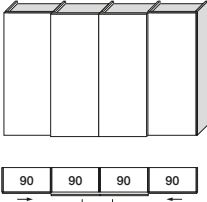
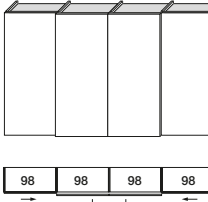
B. 361,6 cm		B. 372,5 cm		B. 404,5 cm	
					
Art.-Nr.	Art.-Nr.	Art.-Nr.	Art.-Nr.	Art.-Nr.	Art.-Nr.
312768	312771	312772	312371	312372	312472
m ² 1,08	m ² 1,14	m ² 1,22	m ² 1,22	m ² 1,30	m ² 1,38
312368	312471				
m ² 1,14	m ² 1,30				
312468					
m ² 1,20					
3.886	4.452	4.655			
4.323	4.962	5.148			
5.004	5.654	5.901			
5.844	6.520	6.827			
3.893	4.573	4.703			
4.164	4.876	5.036			
4.378	5.105	5.274			
4.753	5.490	5.676			
7.330	8.146	8.449			
5.461	6.238	6.481			

B. 361,6 cm		B. 372,5 cm		B. 404,5 cm	
ATHENA	GOLA SMART	ATHENA	GOLA SMART	ATHENA	GOLA SMART
+ 730	+ 373	+ 973	+ 498	+ 973	+ 498
+ 260	+ 260	+ 341	+ 341	+ 341	+ 341
+ 211	+ 211	+ 276	+ 276	+ 276	+ 276

MODULE MIT SCHIEBETÜREN **DORIS - DORIS 2 SETTORI**

MT Ausführungen Rau

CNV	Canvas	RSB	Eiche Sand
NAM	Nussbaum Bernstein	RMK	Eiche Mokka
YUT	Yuta	RC	Eiche Kohlegrau
LIN	Leinen	RNC	Astig hell
OC BG	Matt Gipsweiß	RNN	Astig Natur
OC MP	Matt Perlmutt	CC	Zement hell
OC ARN	Matt Arena	CV	Zement Cava
OC BA	Matt Basaltgrau	CLC	Kalk hell
OC MA	Matt mergel	CLS	Kalk dunkel
OC AN	Matt Anthrazit	ALP	Alpaca
PA BG	Offenporig Gipsweiß	OBR	Oxid brüniert
PA MP	Offenporig Perlmutt		

1/ONE OC BG	Matt Gipsweiß	OC	Matt
1/ONE OC MP	Matt Perlmutt	PA	Offenporig
1/ONE OC ARN	Matt Arena	LC	Glänzend
1/ONE OC BA	Matt Basaltgrau	OCM	Metallic

B. 90 cm

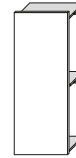

H.	Art.-Nr.
223	310731 m² 0,21
239	310331 m² 0,23
255	310431 m² 0,25
287	310631 m² 0,27

Tür Profile / Griff Innenausführung des Moduls Türausführung

DORIS / DORIS 2 SETTORI

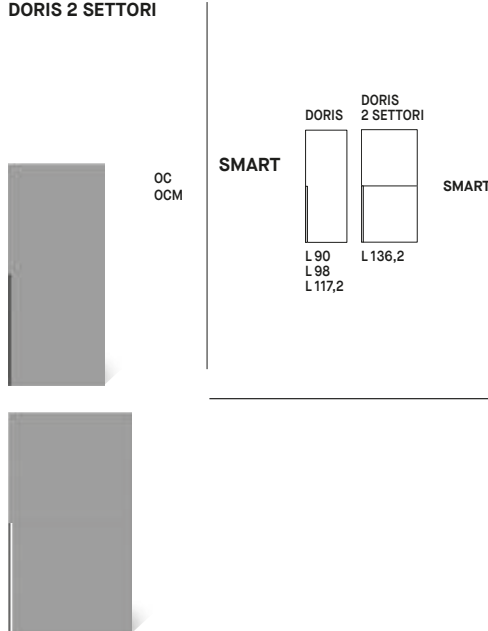

		929	990
MT OC (BG-MP-ARN-BA-MA-AN) MT PA (BG-MP) MT RSB MT RMK MT RC	MT CC MT CV MT CLC MT CLS	MT RNC MT RNN MT ALP MT OBR	985 1.052
1/ONE OC (BG-MP-ARN-BA)			1.031 1.149
OC	PA		1.104 1.244
LC	OCM		1.555 1.666

Für Beleuchtung siehe Seite 238



Die Module, Seitenwände und Trennwände sind auch in T. 42 cm erhältlich, ohne Aufpreis.

AUFPREIS

SCHRANK PRO CM

BREITENZUSCHNITT

HÖHENZUSCHNITT

TIEFENZUSCHNITT

B. 90 cm

DORIS - DORIS 2 SETTORI

+ 124

+65

+45

32 Für lackierte Innenausführung siehe Seite 220-221

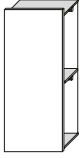
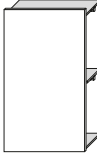
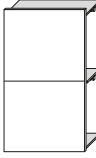
B. 98 cm		B. 117,2 cm		B. 136,2 cm		Abschluss-Seitenwand St. 2,5 T. 59,5/62,8/63,3																							
						<table border="1"> <thead> <tr> <th>H.</th> <th colspan="2">Art.-Nr.</th> </tr> </thead> <tbody> <tr> <td>223</td> <td>314701</td> <td>m² 0,11</td> </tr> <tr> <td>239</td> <td>314301</td> <td>m² 0,11</td> </tr> <tr> <td>255</td> <td>314401</td> <td>m² 0,11</td> </tr> <tr> <td>287</td> <td></td> <td>314601 m² 0,11</td> </tr> </tbody> </table>			H.	Art.-Nr.		223	314701	m ² 0,11	239	314301	m ² 0,11	255	314401	m ² 0,11	287		314601 m ² 0,11						
H.	Art.-Nr.																												
223	314701	m ² 0,11																											
239	314301	m ² 0,11																											
255	314401	m ² 0,11																											
287		314601 m ² 0,11																											
Art.-Nr.		Art.-Nr.		Art.-Nr.		<table border="1"> <thead> <tr> <th colspan="3">SMART</th> </tr> <tr> <th colspan="3">Ausführung auf 2 Seiten</th> </tr> </thead> <tbody> <tr> <td>MT:</td> <td></td> <td></td> </tr> <tr> <td>OC (BG-MP-ARN-BA-MA-AN)</td> <td></td> <td></td> </tr> <tr> <td>PA (BG-MP) / RSB / RMK</td> <td>128</td> <td>128</td> </tr> <tr> <td>RC / RNC / RNN / CC / CV</td> <td></td> <td></td> </tr> <tr> <td>CLC / CLS / ALP / OBR</td> <td></td> <td></td> </tr> </tbody> </table>			SMART			Ausführung auf 2 Seiten			MT:			OC (BG-MP-ARN-BA-MA-AN)			PA (BG-MP) / RSB / RMK	128	128	RC / RNC / RNN / CC / CV			CLC / CLS / ALP / OBR		
SMART																													
Ausführung auf 2 Seiten																													
MT:																													
OC (BG-MP-ARN-BA-MA-AN)																													
PA (BG-MP) / RSB / RMK	128	128																											
RC / RNC / RNN / CC / CV																													
CLC / CLS / ALP / OBR																													
310734 m ² 0,23		310738 m ² 0,28		310741 m ² 0,33		<table border="1"> <thead> <tr> <th colspan="3">SMART</th> </tr> <tr> <th colspan="3">Ausführung Innenseite Stoffoptik / Alpaca</th> </tr> </thead> <tbody> <tr> <td>MT:</td> <td></td> <td></td> </tr> <tr> <td>OC (BG-MP-ARN-BA-MA-AN)</td> <td></td> <td></td> </tr> <tr> <td>PA (BG-MP) / RSB / RMK</td> <td>128</td> <td>128</td> </tr> <tr> <td>RC / RNC / RNN / CC / CV</td> <td></td> <td></td> </tr> <tr> <td>CLC / CLS / ALP / OBR</td> <td></td> <td></td> </tr> </tbody> </table>			SMART			Ausführung Innenseite Stoffoptik / Alpaca			MT:			OC (BG-MP-ARN-BA-MA-AN)			PA (BG-MP) / RSB / RMK	128	128	RC / RNC / RNN / CC / CV			CLC / CLS / ALP / OBR		
SMART																													
Ausführung Innenseite Stoffoptik / Alpaca																													
MT:																													
OC (BG-MP-ARN-BA-MA-AN)																													
PA (BG-MP) / RSB / RMK	128	128																											
RC / RNC / RNN / CC / CV																													
CLC / CLS / ALP / OBR																													
310334 m ² 0,25		310338 m ² 0,30		310341 m ² 0,35		<table border="1"> <tbody> <tr> <td>OC / PA</td> <td>210</td> <td>274</td> </tr> <tr> <td>LC / OCM</td> <td>450</td> <td>555</td> </tr> </tbody> </table>			OC / PA	210	274	LC / OCM	450	555															
OC / PA	210	274																											
LC / OCM	450	555																											
310434 m ² 0,27		310438 m ² 0,32		310441 m ² 0,37																									
	310634 m ² 0,29		310638 m ² 0,35																										
957	1.020	1.072	1.148	1.248																									
1.019	1.091	1.133	1.218	1.311																									
1.084	1.196	1.246	1.336	1.445																									
1.151	1.301	1.336	1.455	1.511																									
1.672	1.794	1.915	2.059	-																									

B. 98 cm		B. 117,2 cm		B. 136,2 cm		Kürzung Seitenwand und Trennwand		
DORIS - DORIS 2 SETTORI		DORIS - DORIS 2 SETTORI		DORIS - DORIS 2 SETTORI				
+ 124		+ 124		+ 184		-		
+ 65		+ 65		+ 81		+16		
+ 49		+ 49		+ 49		+16		

MODULE MIT SCHIEBETÜREN **DORIS - DORIS 2 SETTORI**

MT Ausführungen Rau

CNV Canvas	RSB Eiche Sand
NAM Nussbaum Bernstein	RMK Eiche Mokka
YUT Yuta	RC Eiche Kohlegrau
LIN Leinen	RNC Astig hell
OC BG Matt Gipsweiß	RNN Astig Natur
OC MP Matt Perlmutt	CC Zement hell
OC ARN Matt Arena	CV Zement Cava
OC BA Matt Basaltgrau	CLC Kalk hell
OC MA Matt mergel	CLS Kalk dunkel
OC AN Matt Anthrazit	ALP Alpaca
PA BG Offenporig Gipsweiß	OBR Oxid brüniert
PA MP Offenporig Perlmutt	

1/ONE OC BG Matt Gipsweiß	OC Matt
1/ONE OC MP Matt Perlmutt	PA Offenporig
1/ONE OC ARN Matt Arena	LC Glänzend
1/ONE OC BA Matt Basaltgrau	OCM Metallic

B. 187,5 cm

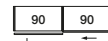
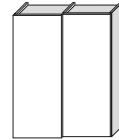

H.	Art.-Nr.
223	312761 m³ 0,60
239	312361 m³ 0,64
255	312461 m³ 0,68
287	312661 m³ 0,69

Tür	Profile / Griff	Innenausführung des Moduls	Türausführung
-----	-----------------	----------------------------	---------------

DORIS / DORIS 2 SETTORI

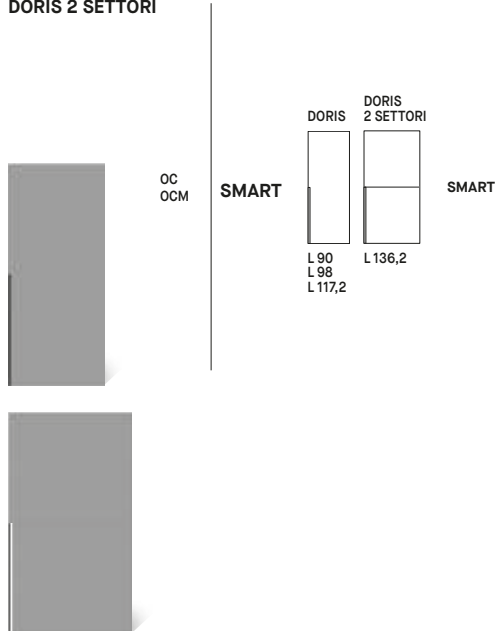

		2.135	2.396
MT OC (BG-MP-ARN-BA-MA-AN) MT PA (BG-MP) MT RSB MT RMK MT RC	MT CC MT CV MT CLC MT CLS	MT RNC MT RNN MT ALP MT OBR	2.334 2.616
1/ONE OC (BG-MP-ARN-BA)			2.425 2.809
OC	PA		2.736 3.196
LC	OCM		4.119 4.602

Für Beleuchtung siehe Seite 238

Die Zusammenstellungen sind auch in T. 42 cm erhältlich, ohne Aufpreis.		B. 187,5 cm
AUFPREIS		DORIS - DORIS 2 SETTORI
SCHRANK PRO CM	BREITENZUSCHNITT	+ 249
	HÖHENZUSCHNITT	+ 178
	TIEFENZUSCHNITT	+ 146

34 Für lackierte Innenausführung siehe Seite 220-221

B. 203,5 cm		B. 241,9 cm		B. 279,9 cm		B. 280 cm	
Art.-Nr.		Art.-Nr.		Art.-Nr.		Art.-Nr.	
312762 m ² 0,64		312763 m ² 0,73		312764 m ² 0,84		312766 m ² 0,87	
312362 m ² 0,68		312363 m ² 0,78		312364 m ² 0,88		312366 m ² 0,93	
312462 m ² 0,72		312463 m ² 0,82		312464 m ² 0,92		312466 m ² 0,99	
	312662 m ² 0,73		312663 m ² 0,85				312666 m ² 1,03
2.191	2.456	2.421	2.711	2.773	3.172	3.546	
2.401	2.694	2.630	2.947	2.985	3.427	3.830	
2.531	2.904	2.855	3.183	3.253	3.564	4.119	
2.829	3.311	3.199	3.618	3.550	3.949	4.601	
4.352	4.859	4.839	5.389	-	5.782	6.429	

B. 203,5 cm	B. 241,9 cm	B. 279,9 cm	B. 280 cm
DORIS - DORIS 2 SETTORI	DORIS - DORIS 2 SETTORI	DORIS - DORIS 2 SETTORI	DORIS - DORIS 2 SETTORI
+ 249	+ 249	+ 368	+ 260
+ 178	+ 178	+ 211	+ 260
+ 146	+ 146	+ 146	+ 211

MODULE MIT SCHIEBETÜREN **DORIS - DORIS 2 SETTORI**

MT Ausführungen Rau

CNV	Canvas	RSB	Eiche Sand
NAM	Nussbaum Bernstein	RMK	Eiche Mokka
YUT	Yuta	RC	Eiche Kohlegrau
LIN	Leinen	RNC	Astig hell
OC BG	Matt Gipsweiß	RNN	Astig Natur
OC MP	Matt Perlmutt	CC	Zement hell
OC ARN	Matt Arena	CV	Zement Cava
OC BA	Matt Basaltgrau	CLC	Kalk hell
OC MA	Matt mergel	CLS	Kalk dunkel
OC AN	Matt Anthrazit	ALP	Alpaca
PA BG	Offenporig Gipsweiß	OBR	Oxid brüniert
PA MP	Offenporig Perlmutt		

1/ONE OC BG	Matt Gipsweiß	OC	Matt
1/ONE OC MP	Matt Perlmutt	PA	Offenporig
1/ONE OC ARN	Matt Arena	LC	Glänzend
1/ONE OC BA	Matt Basaltgrau	OCM	Metallic

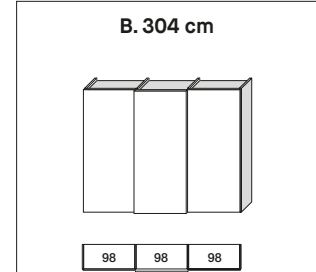

H.	Art.-Nr.
223	312767 m² 0,93
239	312367 m² 0,99
255	312467 m² 1,05
287	312667 m² 1,09

Tür Profile / Griff Innenausführung des Moduls Türausführung

DORIS / DORIS 2 SETTORI

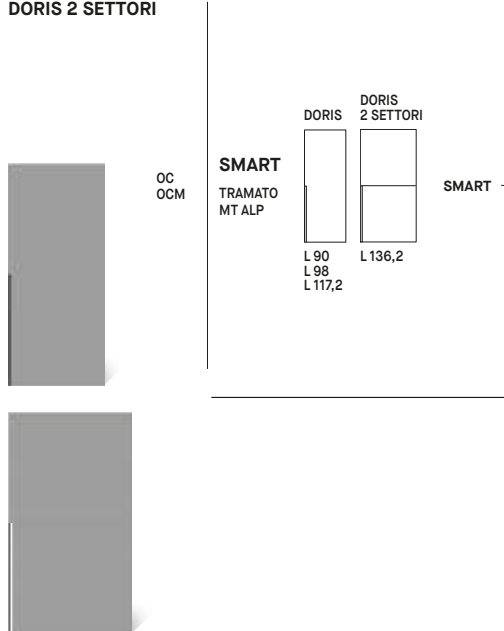

MT OC (BG-MP-ARN-BA-MA-AN)	MT CC	MT RNC
MT PA (BG-MP)	MT CV	MT RNN
MT RSB	MT CLC	MT ALP
MT RMK	MT CLS	MT OBR
MT RC		

	3.257	3.637
	3.528	3.947
	3.723	4.261
	4.088	4.773
	6.132	6.817

Für Beleuchtung siehe Seite 238

Die Zusammenstellungen sind auch in T. 42 cm erhältlich, ohne Aufpreis.		B. 304 cm
AUPPREIS		DORIS - DORIS 2 SETTORI
SCHRANK PRO CM	BREITENZUSCHNITT	+ 373
	HÖHENZUSCHNITT	+ 260
	TIEFENZUSCHNITT	+ 211

36 Für lackierte Innenausführung siehe Seite 220-221

B. 361,6 cm		B. 372,5 cm		B. 404,5 cm	
Art.-Nr.		Art.-Nr.		Art.-Nr.	
312768 m³ 1,08		312771 m³ 1,14		312772 m³ 1,22	
312368 m³ 1,14		312371 m³ 1,22		312372 m³ 1,30	
312468 m³ 1,20		312471 m³ 1,30		312472 m³ 1,38	
	312668 m³ 1,27		312671 m³ 1,46		312672 m³ 1,54
3.600	4.020	4.209	4.322	4.322	4.818
3.872	4.326	4.521	4.655	4.655	5.199
4.209	4.680	4.703	4.915	4.915	5.619
4.643	5.234	5.161	6.006	5.347	6.235
6.862	7.610	7.445	8.255	7.913	8.770

B. 361,6 cm	B. 372,5 cm	B. 404,5 cm
DORIS - DORIS 2 SETTORI	DORIS - DORIS 2 SETTORI	DORIS - DORIS 2 SETTORI
+ 373	+ 498	+ 498
+ 260	+ 341	+ 341
+ 211	+ 276	+ 276

STRUKTUR FÜR MITTLERES BÜCHERREGAL

MT Ausführungen Rau

CNV Canvas	RMK Eiche Mokka
NAM Nussbaum Bernstein	RC Eiche Kohlegrau
YUT Yuta	RNC Astig hell
LIN Leinen	RNN Astig Natur
OC BG Matt Gipsweiß	RNS Astig dunkel
OC MP Matt Perlmutt	CC Zement hell
OC ARN Matt Arena	CS Zement dunkel
OC BA Matt Basaltgrau	CV Zement Cava
OC MA Matt mergel	CLC Kalk hell
OC AN Matt Anthrazit	CLS Kalk dunkel
PA BG Offenporig Gipsweiß	ALP Alpaca
PA MP Offenporig Perlmutt	OBR Oxid brüniert
RSB Eiche Sand	

OC Matt
PA Offenporig
LC Glänzend
OCM Metallic

ANM.: H. 223 cm mit einem Einlegeboden weniger als auf der Zeichnung.
H. 287 mit einem Einlegeboden mehr als auf der Zeichnung.

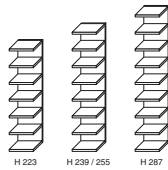

Ausführung		T. 28,2 cm		T. 37,8 cm	
		Art.-Nr.		Art.-Nr.	
MT OC (BG-MP-ARN-BA-MA-AN) MT PA (BG-MP) MT RSB	MT RMK MT RC MT CC	MT CV MT CS MT CLC	MT CLS MT RNC MT RNN	MT RNS MT ALP MT OBR	
OC	PA	453	510	496	559
LC	OCM	805	903	857	962

B. 33 cm					
		T. 28,2 cm		T. 37,8 cm	
H.	Art.-Nr.	Art.-Nr.		Art.-Nr.	
223	311721 m³ 0,11			311731 m³ 0,11	
239	311321 m³ 0,11			311331 m³ 0,11	
255	311421 m³ 0,11			311431 m³ 0,11	
287		311621 m³ 0,12		311631 m³ 0,12	

MODULE FÜR ABSCHLUSS-BÜCHERREGAL

MT Ausführungen Rau

OC BG Matt Gipsweiß	RMK Eiche Mokka
OC MP Matt Perlmutt	RC Eiche Kohlegrau
OC ARN Matt Arena	RNC Astig hell
OC BA Matt Basaltgrau	RNN Astig Natur
OC MA Matt mergel	RNS Astig dunkel
OC AN Matt Anthrazit	CC Zement hell
PA BG Offenporig Gipsweiß	CS Zement dunkel
PA MP Offenporig Perlmutt	CV Zement Cava
RSB Eiche Sand	CLC Kalk hell
	CLS Kalk dunkel
	ALP Alpaca
	OBR Oxid brüniert

OC Matt
PA Offenporig
LGN PA Holz offenporig lackiert
LC Glänzend
OCM Metallic

ANM.: H. 223 cm mit einem Einlegeboden weniger als auf der Zeichnung.
H. 287 mit einem Einlegeboden mehr als auf der Zeichnung.

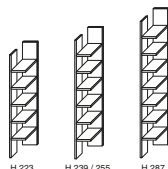

Ausführung		LINKS		RECHTS	
		Art.-Nr.		Art.-Nr.	
MT OC (BG-MP-ARN-BA-MA-AN) MT PA (BG-MP) MT RSB	MT RMK MT RC MT CC	MT CV MT CS MT CLC	MT CLS MT RNC MT RNN	MT RNS MT ALP MT OBR	
OC	PA	823	956	823	956
LC	OCM	1.072	1.217	1.072	1.217
		1.520	1.730	1.520	1.730

B. 31 T. 59,5 cm					
		LINKS		RECHTS	
H.	Art.-Nr.	Art.-Nr.		Art.-Nr.	
223	311736S m³ 0,47			311736D m³ 0,47	
239	311336S m³ 0,49			311336D m³ 0,49	
255	311436S m³ 0,51			311436D m³ 0,51	
287		311636S m³ 0,54		311636D m³ 0,54	

H. 223/239/255/287

B. 51 cm				B. 69 cm				Bücherregal	
T. 28,2 cm		T. 37,8 cm		T. 28,2 cm		T. 37,8 cm		33 - 51 - 69	
Art.-Nr.		Art.-Nr.		Art.-Nr.		Art.-Nr.		MITTLERES BÜCHERREGAL	
311722 m² 0,13		311732 m² 0,13		311723 m² 0,14		311733 m² 0,14			
311322 m² 0,13		311332 m² 0,13		311323 m² 0,14		311333 m² 0,14			
311422 m² 0,13		311432 m² 0,13		311423 m² 0,14		311433 m² 0,14			
	311622 m² 0,14		311632 m² 0,14		311623 m² 0,15		311633 m² 0,15		
568	639	628	707	700	777	743	825		
801	905	827	934	990	1.116	1.042	1.175		
1.003	1.133	1.000	1.231	1.206	1.340	1.284	1.428		

H. 223/239/255/287

	H. 223 - 239 - 255 cm	H. 287 cm
Tiefenkürzung	+ 97	+ 97
HÖHENKÜRZUNG nur bei Holz	+ 32	+ 32

* Mit Spiegel in Silberoptik oder Bronzeoptik lieferbar. (im Auftrag angeben). Auf Anfrage nur in Holz lieferbar.

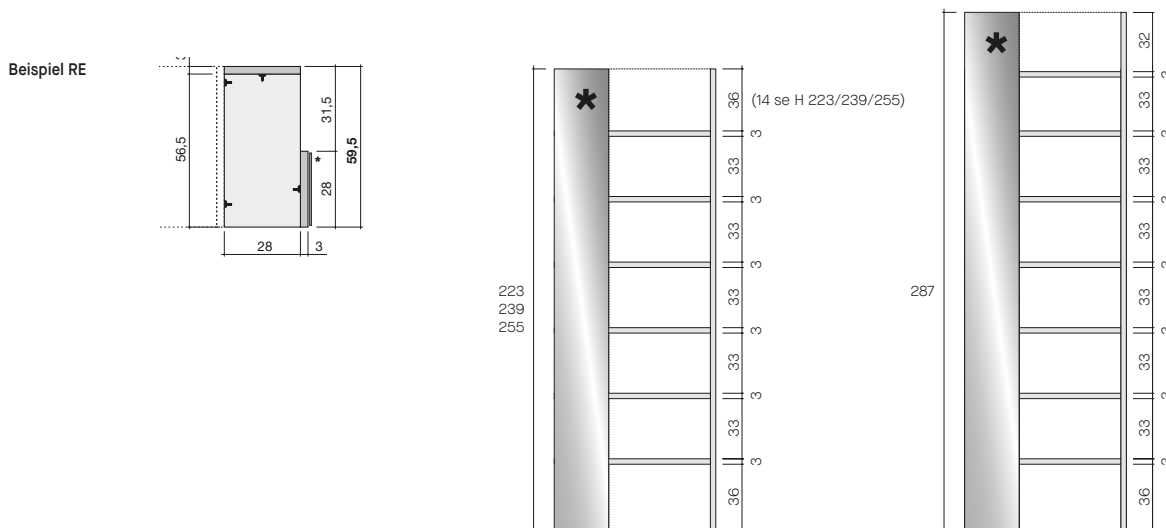

MODULE MIT TV-PANEEL PIVOT/OFFENE MODULE TYP "A" SCHRANK MIT DREHTÜR

MT Ausführungen Rau

CNV Canvas	RSB Eiche Sand
NAM Nussbaum Bernstein	RMK Eiche Mokka
YUT Yuta	RC Eiche Kohlegrau
LIN Leinen	RNC Astig hell
OC BG Matt Gipsweiß	RNN Astig Natur
OC MP Matt Perlmutt	CC Zement hell
OC ARN Matt Arena	CV Zement Cava
OC BA Matt Basaltgrau	CLC Kalk hell
OC MA Matt mergel	CLS Kalk dunkel
OC AN Matt Anthrazit	ALP Alpaca
PA BG Offenporig Gipsweiß	OBR Oxid brüniert
PA MP Offenporig Perlmutt	
OC Matt	
PA Offenporig	

Erhältlich, ohne Aufpreis:
- Fronten Tür Lisca mit Öffnung Push & Pull
- Schubladen und Schubkästen mit flächenbündigem Metallgriff OC

Aufpreis für Frontblende für fixes TV-Modul Pivot aus Metall in Farbe matt € +149

* Die Rückwand des offenen Abteils ist nicht in offenporiger Ausführung erhältlich.

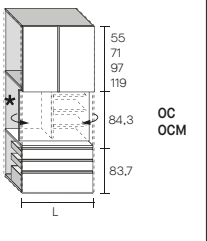
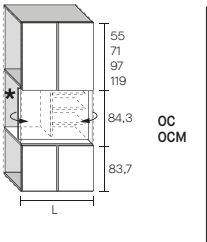
H.	B. 90 cm		B. 98 cm		B. 117,2 cm				
	Art.-Nr.		Art.-Nr.		Art.-Nr.				
223	311711AM m³ 0,17		311712AM m³ 0,17		311713AM m³ 0,25				
239	311311AM m³ 0,21		311312AM m³ 0,21		311313AM m³ 0,27				
255	311411AM m³ 0,25		311412AM m³ 0,25		311413AM m³ 0,29				
287		311611AM m³ 0,27		311612AM m³ 0,28		311613AM m³ 0,33			
Tür	Profile	Innenausführungen	Türausführung						
<p>Modul mit drehbarem TV-Paneel Pivot rechts oder links 2 Türen, 2 Schubladen und 1 Schubkasten</p> 									
		SMART	MT OC (BG-MP-ARN-BA-MA-AN) MT PA (BG-MP) MT RSB MT RMK MT RC MT RNC MT RNN MT CC MT CV MT CLC MT CLS MT ALP MT OBR	1.845	1.914	1.874	1.958	2.028	2.112
		OC	PA	2.335	2.443	2.396	2.510	2.713	2.841
<p>Modul mit drehbarem TV-Paneel Pivot rechts oder links - 4 Türen</p> 									
		SMART	MT OC (BG-MP-ARN-BA-MA-AN) MT PA (BG-MP) MT RSB MT RMK MT RC MT RNC MT RNN MT CC MT CV MT CLC MT CLS MT ALP MT OBR	1.446	1.515	1.463	1.547	1.569	1.654
		OC	PA	1.962	2.070	2.016	2.131	2.240	2.369

MT Ausführungen Rau

CNV Canvas
 NAM Nussbaum Bernstein
 YUT Yuta
 LIN Leinen
 OC BG Matt Gipsweiß
 OC MP Matt Perlmutt
 OC ARN Matt Arena
 OC BA Matt Basaltgrau
 OC MA Matt mergel
 OC AN Matt Anthrazit
 PA BG Offenporig Gipsweiß
 PA MP Offenporig Perlmutt

RSB Eiche Sand
 RMK Eiche Mokka
 RC Eiche Kohlegrau
 RNC Astig hell
 RNN Astig Natur
 CC Zement hell
 CV Zement Cava
 CLC Kalk hell
 CLS Kalk dunkel
 ALP Alpaca
 OBR Oxid brüniert

OC Matt
 PA Offenporig

Erhältlich, ohne Aufpreis:
 - Fronten Tür Lisca mit Öffnung Push & Pull
 - Schubladen und Schubkästen mit flächenbündigem Metallgriff OC

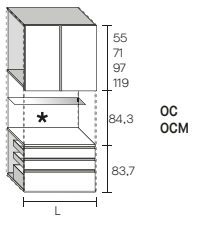
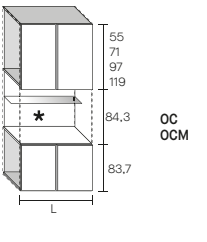
				B. 90 cm		B. 98 cm		B. 117,2 cm			
H.	Art.-Nr.			Art.-Nr.		Art.-Nr.		Art.-Nr.			
223	311721AM m³ 0,17			311722AM m³ 0,17		311723AM m³ 0,25					
239	311321AM m³ 0,21			311322AM m³ 0,21		311323AM m³ 0,27					
255	311421AM m³ 0,25			311422AM m³ 0,25		311423AM m³ 0,29					
287	311621AM m³ 0,27			311622AM m³ 0,28		311623AM m³ 0,33					
<p>Tür Profile Innenausführungen Türausführung</p> <p>Modul mit offenem Abteil und Glaseinlegeboden 2 Türen, 2 Schubladen und 1 Schubkasten</p> 				SMART	MT OC (BG-MP-ARN-BA-MA-AN) MT PA (BG-MP) MT RSB MT RMK MT CV MT RC MT CLC MT RNC MT CLS MT RNN MT ALP MT CC MT OBR	1.278	1.348	1.301	1.384	1.441	1.525
				OC	PA	1.672	1.780	1.720	1.834	2.004	2.133
<p>Modul mit offenem Abteil und Glaseinlegeboden 4 Türen</p> 				SMART	MT OC (BG-MP-ARN-BA-MA-AN) MT PA (BG-MP) MT RSB MT RMK MT CV MT RC MT CLC MT RNC MT CLS MT RNN MT ALP MT CC MT OBR	879	949	890	973	982	1.066
				OC	PA	1.299	1.407	1.340	1.455	1.531	1.660

MODULE MIT TV-PANEEL PIVOT/OFFENE MODULE TYP "B" SCHRANK MIT DREHTÜR

MT Ausführungen Rau

CNV	Canvas	RSB	Eiche Sand
NAM	Nussbaum Bernstein	RMK	Eiche Mokka
YUT	Yuta	RC	Eiche Kohlegrau
LIN	Leinen	RNC	Astig hell
OC BG	Matt Gipsweiß	RNN	Astig Natur
OC MP	Matt Perlmutt	CC	Zement hell
OC ARN	Matt Arena	CV	Zement Cava
OC BA	Matt Basaltgrau	CLC	Kalk hell
OC MA	Matt mergel	CLS	Kalk dunkel
OC AN	Matt Anthrazit	ALP	Alpaca
PA BG	Offenporig Gipsweiß	OBR	Oxid brüniert
PA MP	Offenporig Perlmutt		
OC	Matt		
PA	Offenporig		

Erhältlich, ohne Aufpreis:
- Fronten Tür Lisca mit Öffnung Push & Pull
- Schubladen und Schubkästen mit flächenbündigem Metallgriff OC

Aufpreis für Frontblende für fixes TV-Modul Pivot aus Metall in Farbe matt € +149

* Die Rückwand des offenen Abteils ist nicht in
offenporiger Ausführung erhältlich.

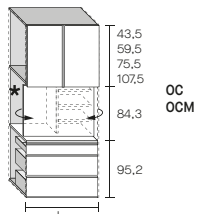
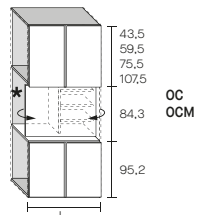
Tür	Profile	Innenausführungen	Türausführung	H.	B. 90 cm		B. 98 cm		B. 117,2 cm			
					Art.-Nr.	Art.-Nr.	Art.-Nr.	Art.-Nr.				
				223	311711BM m³ 0,17		311712BM m³ 0,17		311713BM m³ 0,25			
				239	311311BM m³ 0,21		311312BM m³ 0,21		311313BM m³ 0,27			
				255	311411BM m³ 0,25		311412BM m³ 0,25		311413BM m³ 0,29			
				287		311611BM m³ 0,27		311612BM m³ 0,28		311613BM m³ 0,33		
Modul mit drehbarem TV-Panel Pivot rechts oder links 2 Türen, 1 Schubladen und 2 Schubkästen												
	OC OCM		SMART		MT OC (BG-MP-ARN-BA-MA-AN) MT PA (BG-MP) MT RSB MT RMK MT RC MT RNC MT RNN MT CC	MT CV MT CLC MT CLS MT ALP MT OBR	1.868	1.937	1.898	1.981	2.048	2.133
					OC	PA	2.356	2.464	2.416	2.531	2.735	2.864
Modul mit drehbarem TV-Panel Pivot rechts oder links - 4 Türen												
	OC OCM		SMART		MT OC (BG-MP-ARN-BA-MA-AN) MT PA (BG-MP) MT RSB MT RMK MT RC MT RNC MT RNN MT CC	MT CV MT CLC MT CLS MT ALP MT OBR	1.446	1.515	1.463	1.547	1.569	1.654
					OC	PA	1.962	2.070	2.016	2.131	2.240	2.369

MT Ausführungen Rau

CNV	Canvas
NAM	Nussbaum Bernstein
YUT	Yuta
LIN	Leinen
OC BG	Matt Gipsweiß
OC MP	Matt Perlmutt
OC ARN	Matt Arena
OC BA	Matt Basaltgrau
OC MA	Matt mergel
OC AN	Matt Anthrazit
PA BG	Offenporig Gipsweiß
PA MP	Offenporig Perlmutt

RSB	Eiche Sand
RMK	Eiche Mokka
RC	Eiche Kohlegrau
RNC	Astig hell
RNN	Astig Natur
CC	Zement hell
CV	Zement Cava
CLC	Kalk hell
CLS	Kalk dunkel
ALP	Alpaca
OBR	Oxid brüniert

Erhältlich, ohne Aufpreis:
 - Fronten Tür Lisca mit Öffnung Push & Pull
 - Schubladen und Schubkästen mit flächenbündigem Metallgriff OC

OC	Matt
PA	Offenporig

H.	B. 90 cm		B. 98 cm		B. 117,2 cm	
	Art.-Nr.		Art.-Nr.		Art.-Nr.	
223	311721BM m ³ 0,17		311722BM m ³ 0,17		311723BM m ³ 0,25	
239	311321BM m ³ 0,21		311322BM m ³ 0,21		311323BM m ³ 0,27	
255	311421BM m ³ 0,25		311422BM m ³ 0,25		311423BM m ³ 0,29	
287		311621BM m ³ 0,27		311622BM m ³ 0,28		311623BM m ³ 0,33

* Die Rückwand des offenen Abteils ist nicht in offenporiger Ausführung erhältlich.

Tür Profile Innenausführungen Türausführung

Modul mit offenem
Abteil und
Glaseinlegeboden
2 Türen, 1 Schubladen
und 2 Schubkästen

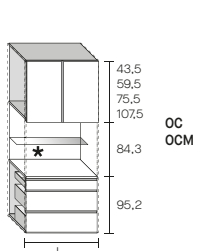

SMART	MT OC (BG-MP-ARN-BA-MA-AN) MT PA (BG-MP) MT RSB MT RMK MT RC MT RNC MT RNN MT CC	MT CV MT CLC MT CLS MT ALP MT OBR	1.301	1.370	1.325	1.408	1.455	1.531
	OC	PA	1.693	1.801	1.740	1.855	1.961	2.046

Modul mit offenem
Abteil und
Glaseinlegeboden
4 Türen

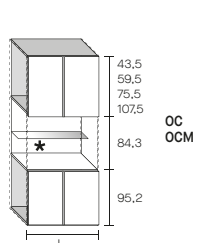

SMART	MT OC (BG-MP-ARN-BA-MA-AN) MT PA (BG-MP) MT RSB MT RMK MT RC MT RNC MT RNN MT CC	MT CV MT CLC MT CLS MT ALP MT OBR	879	949	890	973	2.027	2.156
	OC	PA	1.299	1.407	1.340	1.455	2.320	2.369

AUFPREIS FÜR INNENLACKIERUNG

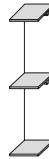
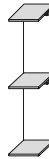
	B. 43,7 cm		B. 47,7 cm		B. 57,3 cm	
						
	H.		H.		H.	
	223		223		223	
	239	287	239	287	239	287
	255		255		255	
Aufpreis für Innenseite in Farbe matt lackiert OC	+ 215	+ 218	+ 220	+ 222	+ 238	+ 244
Aufpreis für nur innere Rückwand in Farbe matt lackiert OC	+ 77	+ 65	+ 74	+ 76	+ 85	+ 92

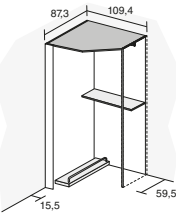
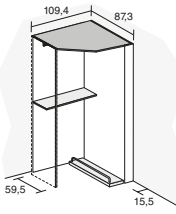
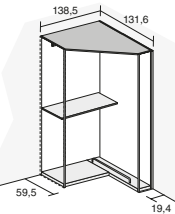
	B. 87,3 x 109,4 cm		B. 109,4 x 87,3 cm		B. 131,6 x 138,5 cm	
						
	H.		H.		H.	
	239		239		239	
	255		255		255	
Aufpreis für Innenseite in Farbe matt lackiert OC	+ 463		+ 463		+ 775	

44 Die Innenlackierung der Module, Seitenwände und Trennwände basiert auf der Ausführung Canvas

Typen- und Preisliste

B. 90 cm		B. 98 cm		B. 117,2 cm		B. 136,2 cm		B. 107,8 x 107,8 cm		B. 43,2 cm*	
H.		H.		H.		H.		H.		H.	
223		223		223		223		223		223	
239	287	239	287	239	287	239	287	239	287	239	287
255		255		255		255		255		255	
+ 372	+ 380	+ 394	+ 402	+ 476	+ 485	+ 610	+ 622	+ 879	+ 894	+ 390	+ 117
+ 145	+ 153	+ 154	+ 162	+ 174	+ 183	+ 145	+ 153	+ 180	+ 194	+ 117	+ 428

B. 138,5 x 131,6 cm		B. 132 x 132 cm		Abschluss-Seitenwand für Module mit Drehtür/Schiebetür St. 2,5 T. 59,5		Abschluss-Seitenwand für Module mit Drehtür/Schiebetür St. 2,5 T. 38,7		Trennwand für Module mit Drehtür/Schiebetür St. 2,5 T. 59,5	
H.		H.		H.		H.		H.	
239		239		223		223		223	
255		255		239	287	239	287	239	287
				255		255		255	
+ 775		+ 679		+ 92	+ 123	+ 92	+ 123	302	396

STRUKTUR FÜR OFFENE SCHRANKKABINE

MODULÜBERSICHT

BREITE

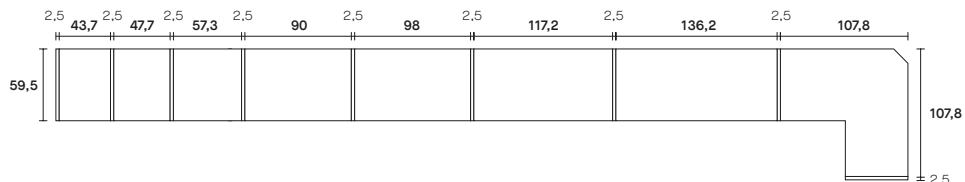

HÖHEN

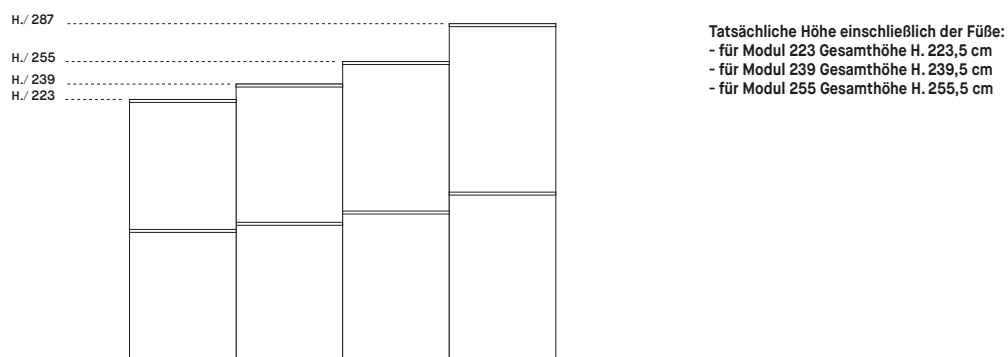

ZUSCHNITTE NACH MASS

		Aufpreis	
	Breitenkürzung bei einem Modul	+ 65	
	Tiefenkürzung bei einem Modul	+ 45	
	Höhenkürzung bei einem Modul	B. 43,7 - 47,7 - 57,3 - 90 - 98 - 117,2 cm	+ 16
		B. 136,2 cm	+ 32
	Kürzung bei Seitenwänden und Trennwänden	Tiefe	+ 16
		Höhe	+ 16

	B. 43,7 cm		B. 47,7 cm		B. 57,3 cm	
H.	Art.-Nr.		Art.-Nr.		Art.-Nr.	
223	300753 m² 0,044		300755 m² 0,048		300757 m² 0,058	
239	300353 m² 0,045		300355 m² 0,049		300357 m² 0,059	
255	300453 m² 0,046		300455 m² 0,050		300457 m² 0,060	
287		300653 m² 0,048		300655 m² 0,052		300657 m² 0,062
STOFFOPTIK / ALPACA	226	238	244	259	278	294
LACKIERT OC	441	456	464	480	516	539

	B. 90 cm		B. 98 cm		B. 117,2 cm	
H.	Art.-Nr.		Art.-Nr.		Art.-Nr.	
223	310761 m² 0,1		310764 m² 0,109		310768 m² 0,13	
239	310361 m² 0,102		310364 m² 0,111		310368 m² 0,132	
255	310461 m² 0,104		310464 m² 0,113		310468 m² 0,134	
287		310661 m² 0,106		310664 m² 0,115		310668 m² 0,137
STOFFOPTIK / ALPACA	344	368	359	385	417	450
LACKIERT OC	716	747	753	787	893	934

	B. 136,2 cm		B. 107,8 x 107,8 cm	
H.	Art.-Nr.		Art.-Nr.	
223	310771 m² 0,151		300773 m² 0,244	
239	310371 m² 0,154		300373 m² 0,249	
255	310471 m² 0,157		300473 m² 0,254	
287		310671 m² 0,160		300673 m² 0,263
STOFFOPTIK / ALPACA	540	599	875	923
LACKIERT OC	1.003	1.052	1.754	1.817

Abschluss-Seitenwand St. 2,5 T. 59,5

H.	Art.-Nr.	
223	314705 m² 0,056	
239	314305 m² 0,060	
255	314405 m² 0,064	
287		314605 m² 0,072

SMART
Ausführung auf 2 Seiten

MT:
OC (BG-MP-ARN-BA-MA-AN)
PA (BG-MP) / RSB / RMK 128 128
RC / RNC / RNN / CC / CV
CLC / CLS / ALP / OBR

SMART
Ausführung Innenseite Stoffoptik / Alpaca

MT:
OC (BG-MP-ARN-BA-MA-AN)
PA (BG-MP) / RSB / RMK 128 128
RC / RNC / RNN / CC / CV
CLC / CLS / ALP / OBR

OC / PA 210 274
LC / OCM 450 555

Trennwand St. 2,5 T. 59,5

H.	Art.-Nr.	
223	314755 m² 0,056	
239	314355 m² 0,060	
255	314455 m² 0,064	
287		314655 m² 0,072

Stoffoptik / Alpaca 108 161
OC 302 396

OFFENE SCHRANKKABINE

Die Innenlackierung der Module, Seitenwände und Trennwände basiert auf der Ausführung Canvas

INNENAUSSTATTUNG

Für Abteil B. 43,7

MT Ausführungen Rau

CNV Canvas
 NAM Nussbaum Bernstein
 YUT Yuta
 LIN Leinen

1501

Serienmässig
 - 2 Kleiderstangen
 - 1 Holzeinlegeboden



1502

Optionaler
 - 3 Holzeinlegeböden



1503

Optionaler
 - 1 Schubkastenelement
 mit 3 Schubladen



	-	156	276
STOFFOPTIK / ALPACA	-	172	337
LACKIERT OC	-	299	428

1504

Optionaler
 - 4 Holzeinlegeböden
 - 1 Schubkastenelement
 mit 3 Schubladen



1505

Optionaler
 - 2 ausziehbare
 Einlegeböden
 - 1 Schubkastenelement
 mit 3 Schubladen



1506

Optionaler
 - 5 Holzeinlegeböden



	567	1.032	287
STOFFOPTIK / ALPACA	567	1.032	287
LACKIERT OC	826	1.123	498

Für Abteil B. 47,7

1511

Serienmässig
 - 2 Kleiderstangen
 - 1 Holzeinlegeboden



1512

Optionaler
 - 3 Holzeinlegeböden



1513

Optionaler
 - 1 Schubkastenelement
 mit 3 Schubladen



	-	172	337
STOFFOPTIK / ALPACA	-	172	337
LACKIERT OC	-	299	428

1514

Optionaler
 - 4 Holzeinlegeböden
 - 1 Schubkastenelement
 mit 3 Schubladen

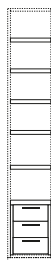

1515

Optionaler
 - 2 ausziehbare
 Einlegeböden
 - 1 Schubkastenelement
 mit 3 Schubladen



1516

Optionaler
 - 5 Holzeinlegeböden



	567	1.032	287
STOFFOPTIK / ALPACA	567	1.032	287
LACKIERT OC	826	1.123	498

48 Die Innenlackierung der Module, Seitenwände und Trennwände basiert auf der Ausführung Canvas

INNENAUSSTATTUNG

Für Abteil B. 57,3

MT Ausführungen Rau

CNV Canvas
 NAM Nussbaum Bernstein
 YUT Yuta
 LIN Leinen

1521

Serienmässig
 - 2 Kleiderstangen
 - 1 Holzeinlegeboden

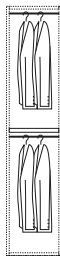

1522

Optionaler
 - 3 Holzeinlegeböden

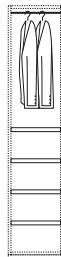

1523

Optionaler
 - 1 Schubkastenelement
 mit 3 Schubladen

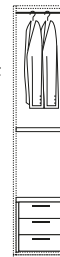

STOFFOPTIK / ALPACA	-	182	363
LACKIERT OC	-	321	458

1524

Optionaler
 - 4 Holzeinlegeböden
 - 1 Schubkastenelement
 mit 3 Schubladen



1525

Optionaler
 - 2 ausziehbare
 Einlegeböden
 - 1 Schubkastenelement
 mit 3 Schubladen

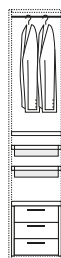

1526

Optionaler
 - 5 Holzeinlegeböden



STOFFOPTIK / ALPACA	606	1.088	303
LACKIERT OC	886	1.182	535

INNENAUSSTATTUNG

Für Abteil B. 90

MT Ausführungen Rau

- CNV Canvas
- NAM Nussbaum Bernstein
- YUT Yuta
- LIN Leinen

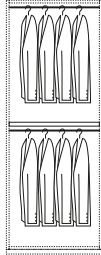
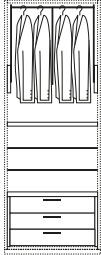
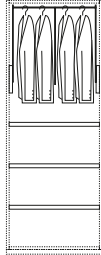
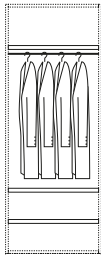
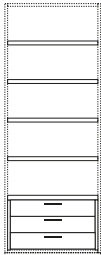
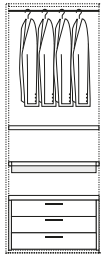
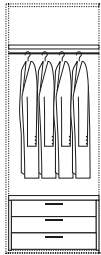
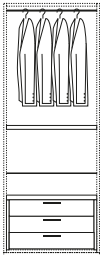
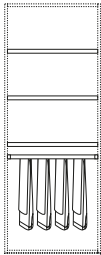
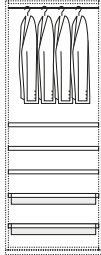
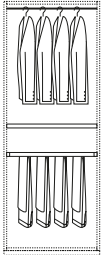
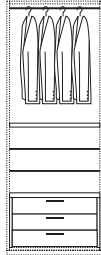
	<p>1551 Serienmässig - 2 Kleiderstangen - 1 Holzeinlegeboden</p> 	<p>1552 Optionaler - 1 Kleiderlift - 2 Glaseinlegeböden - 1 Schubkastenelement mit 3 Schubladen</p> 	<p>1553 Optionaler - 2 Holzeinlegeböden - 1 Kleiderlift</p> 
STOFFOPTIK / ALPACA	-	952	407
LACKIERT OC	-	1.162	575
	<p>1554 Optionaler - 2 Holzeinlegeböden</p> 	<p>1555 Optionaler - 3 Holzeinlegeböden - 1 Schubkastenelement mit 3 Schubladen</p> 	<p>1556 Optionaler - 1 ausziehbarer Einlegeboden - 1 Schubkastenelement mit 3 Schubladen</p> 
STOFFOPTIK / ALPACA	151	616	820
LACKIERT OC	320	1.079	1.030
	<p>1557 Optionaler - 1 Schubkastenelement mit 3 Schubladen</p> 	<p>1558 Optionaler - 1 Glaseinlegeboden - 1 Schubkastenelement mit 3 Schubladen</p> 	<p>1559 Optionaler - 2 Holzeinlegeböden - 1 ausziehbarer Hosenhänger</p> 
STOFFOPTIK / ALPACA	389	543	664
LACKIERT OC	599	753	833
	<p>1560 Optionaler - 2 Holzeinlegeböden - 2 ausziehbare Einlegeböden</p> 	<p>1561 Optionaler - 1 ausziehbarer Hosenhänger</p> 	<p>1562 Optionaler - 2 Glaseinlegeböden - 1 Schubkastenelement mit 3 Schubladen</p> 
STOFFOPTIK / ALPACA	1.012	513	697
LACKIERT OC	1.181	513	906

50 Die Innenlackierung der Module, Seitenwände und Trennwände basiert auf der Ausführung Canvas

INNENAUSSTATTUNG

Für Abteil B. 98

MT Ausführungen Rau

CNV Canvas
 NAM Nussbaum Bernstein
 YUT Yuta
 LIN Leinen

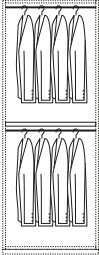
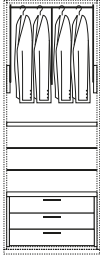
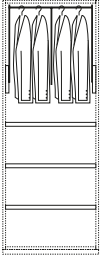
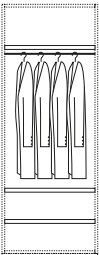
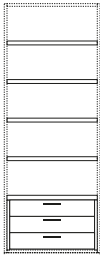
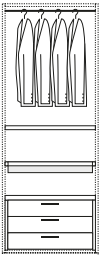
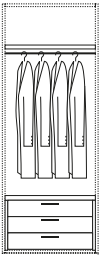
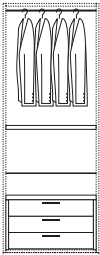
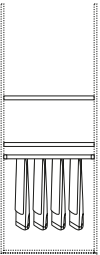
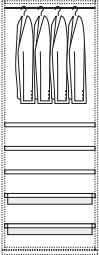
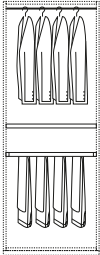
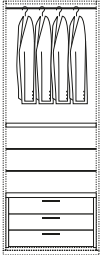
	1571 Serienmässig - 2 Kleiderstangen - 1 Holzeinlegeboden		1572 Optionaler - 1 Kleiderlift - 2 Glaseinlegeböden - 1 Schubkastenelement mit 3 Schubladen		1573 Optionaler - 2 Holzeinlegeböden - 1 Kleiderlift	
STOFFOPTIK / ALPACA	-		437,47		182,36	
LACKIERT OC	-		531,56		258,02	
	1574 Optionaler - 2 Holzeinlegeböden		1575 Optionaler - 3 Holzeinlegeböden - 1 Schubkastenelement mit 3 Schubladen		1576 Optionaler - 1 ausziehbarer Einlegeboden - 1 Schubkastenelement mit 3 Schubladen	
STOFFOPTIK / ALPACA	151		616		820	
LACKIERT OC	320		1.079		1.030	
	1577 Optionaler - 1 Schubkastenelement mit 3 Schubladen		1578 Optionaler - 1 Glaseinlegeboden - 1 Schubkastenelement mit 3 Schubladen		1579 Optionaler - 2 Holzeinlegeböden - 1 ausziehbarer Hosenhänger	
STOFFOPTIK / ALPACA	389		555		664	
LACKIERT OC	599		765		833	
	1580 Optionaler - 2 Holzeinlegeböden - 2 ausziehbare Einlegeböden		1581 Optionaler - 1 ausziehbarer Hosenhänger		1582 Optionaler - 2 Glaseinlegeböden - 1 Schubkastenelement mit 3 Schubladen	
STOFFOPTIK / ALPACA	936		474		666	
LACKIERT OC	1.092		474		860	

Die Innenlackierung der Module, Seitenwände und Trennwände basiert auf der Ausführung Canvas

51

INNENAUSSTATTUNG

Für Abteil B. 117,2

MT Ausführungen Rau

CNV Canvas
 NAM Nussbaum Bernstein
 YUT Yuta
 LIN Leinen

	1601 Serienmässig - 2 Kleiderstangen - 1 Holzeinlegeboden		1602 Optionaler - 1 Holzeinlegeboden - 1 Schubkastenelement mit 3 Schubladen		1603 Optionaler - 2 Holzeinlegeböden - 1 Kleiderlift	
STOFFOPTIK / ALPACA	-		542		424	
LACKIERT OC	-		841		616	
	1604 Optionaler - 1 Trennwand H. 117,7 / 122,2 - 3 Glaseinlegeböden B. 57,3 - 1 ausziehbarer Einsatz B. 57,3 - 1 Schubkastenelement mit 3 Schubladen B. 57,3		1605 Optionaler - 3 Holzeinlegeböden - 1 Schubkastenelement mit 3 Schubladen		1606 Optionaler - 1 Trennwand H. 181,7 / 186,2 - 4 Holzeinlegeböden B. 57,3	
STOFFOPTIK / ALPACA	1.106		626		318	
LACKIERT OC	1.299		1.022		655	
	1607 Optionaler - 1 Trennwand H. 117,7 / 122,2 - 3 Glaseinlegeböden B. 57,3		1608 Optionaler - 1 Trennwand H. 181,7 / 186,2 - 1 Holzeinlegeboden B. 57,3 - 1 Schubkastenelement mit 3 Schubladen B. 57,3		1609 Optionaler - 1 Trennwand H. 181,7 / 186,2 - 3 Glaseinlegeböden B. 57,3 - 2 Holzeinlegeböden B. 57,3 - 1 Schubkastenelement mit 3 Schubladen B. 57,3	
STOFFOPTIK / ALPACA	381		500		885	
LACKIERT OC	479		792		1.223	
	1610 Optionaler - 1 Trennwand H. 181,7 / 186,2 - 6 Glaseinlegeböden B. 57,3 - 1 Schubkastenelement mit 3 Schubladen B. 57,3		1611 Optionaler - 1 Trennwand H. 181,7 / 186,2 - 3 Glaseinlegeböden B. 57,3 - 2 Holzeinlegeböden B. 57,3 - 1 Schubkastenelement mit 3 Schubladen B. 57,3		1612 Optionaler - 5 Holzeinlegeböden	
STOFFOPTIK / ALPACA	1.088		885		422	
LACKIERT OC	1.334		1.223		903	

52 Die Innenlackierung der Module, Seitenwände und Trennwände basiert auf der Ausführung Canvas

INNENAUSSTATTUNG

Für Abteil B. 136,2

MT Ausführungen Rau

CNV Canvas
 NAM Nussbaum Bernstein
 YUT Yuta
 LIN Leinen

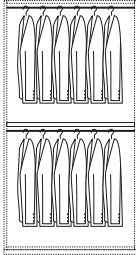
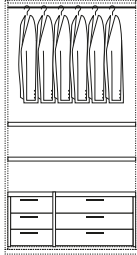
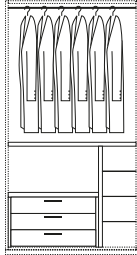
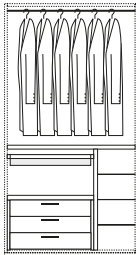
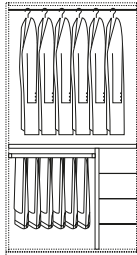
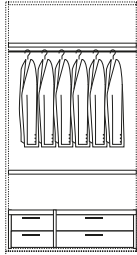
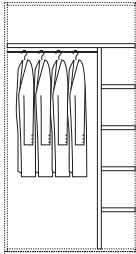
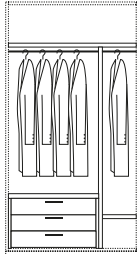
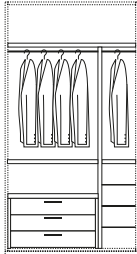
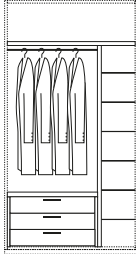
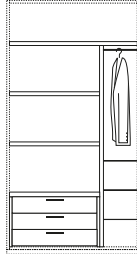
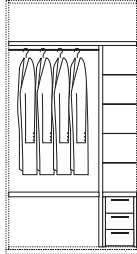
	<p>1651 Serienmässig - 2 Kleiderstangen - 1 Holzeinlegeboden</p> 	<p>1652 Optionaler - 1 Holzeinlegeboden - 1 Schubkastenelement mit 6 Schubladen</p> 	<p>1653 Optionaler - 1 Trennwand H. 117,7 - 3 Glaseinlegeböden B. 43,7 - Schubladen B. 90</p> 
STOFFOPTIK / ALPACA	-	871	705
LACKIERT OC	-	1.369	1.013
	<p>1654 Optionaler - 1 Trennwand H. 117,7 - 3 Glaseinlegeböden B. 43,7 - 1 Schubkastenelement mit 3 Schubladen B. 90 - Schubladen B. 90</p> 	<p>1655 Optionaler - 1 Trennwand H. 117,7 - 3 Glaseinlegeböden B. 43,7 - 1 ausziehbarer Hosenhänger B. 90</p> 	<p>1656 Optionaler - 1 Holzeinlegeboden - 1 Schubkastenelement mit 4 Schubladen</p> 
STOFFOPTIK / ALPACA	1.136	828	765
LACKIERT OC	1.444	927	1.226
	<p>1657 Optionaler - 1 Trennwand H. 181,7 - 4 Holzeinlegeböden B. 43,7</p> 	<p>1658 Optionaler - 1 Trennwand H. 181,7 - 1 Holzeinlegeboden B. 43,7 - Schubladen B. 90</p> 	<p>1659 Optionaler - 1 Trennwand H. 181,7 - 3 Glaseinlegeböden B. 43,7 - 1 Holzeinlegeboden B. 90 + 1 Holzeinlegeboden B. 43,7 - Schubladen B. 90</p> 
STOFFOPTIK / ALPACA	305	522	858
LACKIERT OC	625	926	1.345
	<p>1660 Optionaler - 1 Trennwand H. 181,7 - 6 Glaseinlegeböden B. 43,7 - Schubladen B. 90</p> 	<p>1661 Optionaler - 1 Trennwand H. 181,7 - 3 Glaseinlegeböden B. 43,7 - 2 Holzeinlegeböden B. 90 - Schubladen B. 90</p> 	<p>1662 Optionaler - 1 Trennwand H. 181,7 - 4 Glaseinlegeböden B. 43,7 - 1 Holzeinlegeboden B. 90 - 1 Schubkastenelement mit 3 Schubladen B. 43,7</p> 
STOFFOPTIK / ALPACA	984	876	835
LACKIERT OC	1.345	1.406	1.162

Die Innenlackierung der Module, Seitenwände und Trennwände basiert auf der Ausführung Canvas

53

INNENAUSSTATTUNG

MT Ausführungen Rau: CNV Canvas / NAM Nussbaum Bernstein / YUT Yuta / LIN Leinen

Die Module, Seitenwände und Trennwände sind auch in T. 42 cm erhältlich, ohne Aufpreis.

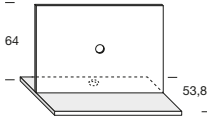
	Für Abteil B.	Art.-Nr.	MT CNV MT NAM MT YUT MT LIN	STOFFOPTIK / ALPAGA	LACKIERT OC
 <p>Einlegeboden und Rückwand für TV-Element (inklusive Abdeckung für Kabeldurchlass)</p>	90 cm	309031	368	388	530
	98 cm	309034	393	412	573
	117,2 cm	309038	419	451	644

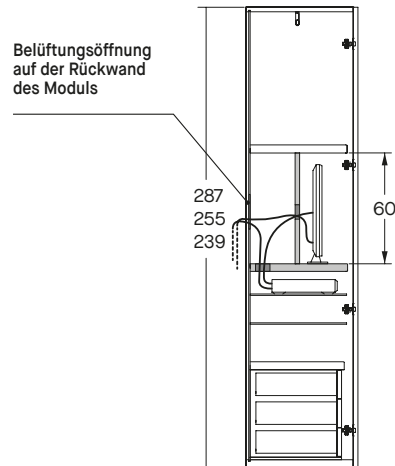

Schrankabteil B. 90 - 98 - 117,2 für TV-Gerät

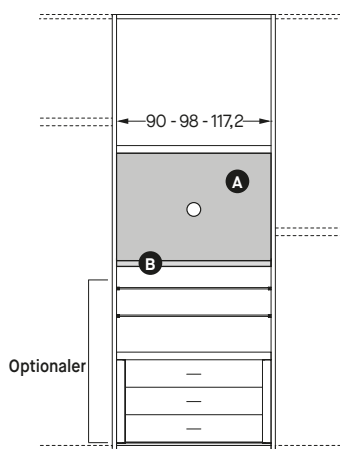

Schrankabteil B. 136,2 für TV-Gerät

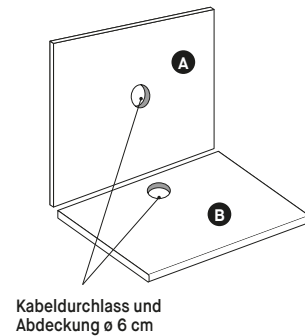
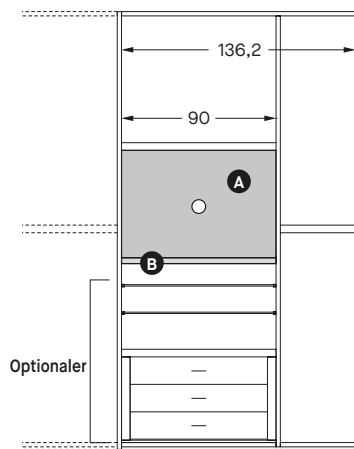

54 Die Innenlackierung der Module, Seitenwände und Trennwände basiert auf der Ausführung Canvas

INNENAUSSTATTUNG

Anstelle der Schubladen ist ohne Aufpreis ein Schubkasten erhältlich – zur Art.-Nr. des Schubkastenelements je nach gewählter Zusammenstellung C1, C2 oder C3 hinzufügen. Die Schubladenelemente sind ohne Aufpreis auch in T. 42 cm erhältlich.

Breitenkürzung für jeden einzelnen Schubladen € 30			STOFFOPTIK / ALPACA	LACKIERT OC
	Für Abteil B.	Art.-Nr.		
Inneres Schubkastenelement mit 2 Schubladen mit Führungen mit „Soft-Schließsystem“ 	43,7 cm	309301	269	370
	47,7 cm	309302	269	370
	57,3 cm	309304	291	397
	90 cm	309306	350	514
	98 cm	309307	350	514
	117,2 cm	309308	382	567
Inneres Schubkastenelement mit 3 Schubladen mit Führungen mit „Soft-Schließsystem“ 	43,7 cm	309311	337	428
	47,7 cm	309312	337	428
	57,3 cm	309314	363	458
	90 cm	309316	389	459
	98 cm	309317	389	459
	117,2 cm	309318	458	661
Inneres Schubkastenelement mit 4 Schubladen mit Führungen mit „Soft-Schließsystem“ 	43,7 cm	309321	411	459
	47,7 cm	309322	411	459
	57,3 cm	309324	439	493
	90 cm	309326	519	654
	98 cm	309327	519	654
	117,2 cm	309328	586	731
Inneres Schubkastenelement mit 5 Schubladen mit Führungen mit „Soft-Schließsystem“ 	43,7 cm	309331	478	532
	47,7 cm	309332	478	532
	57,3 cm	309334	512	572
	90 cm	309336	628	760
	98 cm	309337	628	760
	117,2 cm	309338	693	845
Inneres Schubkastenelement mit 6 Schubladen mit Führungen mit „Soft-Schließsystem“ 	43,7 cm	309341	554	606
	47,7 cm	309342	554	606
	57,3 cm	309344	588	649
	90 cm	309346	741	859
	98 cm	309347	741	859
	117,2 cm	309348	795	943

Die Innenlackierung der Module, Seitenwände und Trennwände basiert auf der Ausführung Canvas

55

INNENAUSSTATTUNG

Die Schubladenelemente sind ohne Aufpreis auch in T. 42 cm erhältlich.

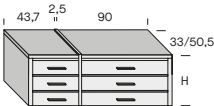
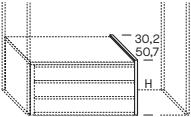
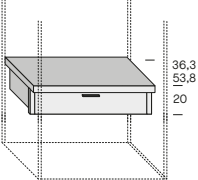
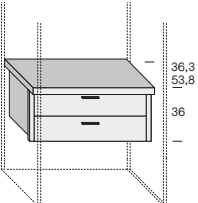
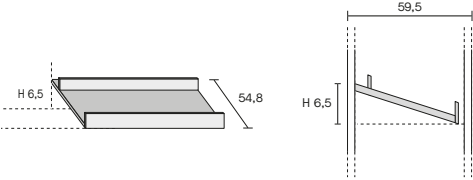
Breitenkürzung für jeden einzelnen Schubladen € 30			STOFFOPTIK / ALPAGA	LACKIERT OC	
	Für Abteil B.	Art.-Nr.			
Inneres Schubkastenelement mit Führungen mit „Soft-Schließsystem“ 	4 Schubladen H. 36,4	136,2 cm	309309	665	1.007
	6 Schubladen H. 52,4	136,2 cm	309319	771	1.150
	8 Schubladen H. 68,4	136,2 cm	309329	974	1.236
	10 Schubladen H. 84,4	136,2 cm	309339	1.151	1.415
	12 Schubladen H. 100,4	136,2 cm	309349	1.339	1.588
	Anstelle der Schubladen ist ohne Aufpreis ein Schubkasten erhältlich – zur Art.-Nr. des Schubkastenelements je nach gewählter Zusammenstellung C1, C2 oder C3 hinzufügen.				
Abschluss-Seitenwand für Schubkastenelement (immer dann einzusetzen, wenn das Schubkastenelement kleiner als das vorgesehene Abteil ist - z. B. Abteil 136,2 mit Schubkastenelement von 90) 	2 Schubladen H. 36,4		309500	45	124
	3 Schubladen H. 52,4		309501	45	124
	4 Schubladen H. 68,4		309502	45	124
	5 Schubladen H. 84,4		309503	45	124
	6 Schubladen H. 100,4		309504	45	124
Inneres hängendes Schubkastenelement mit 1 Schublade (inklusive Abdeckplatte/Struktur-Einlegeboden) 	43,7 cm		309381	260	386
	47,7 cm		309382	260	386
	57,3 cm		309384	283	415
	90 cm		309386	354	541
	98 cm		309387	354	541
	117,2 cm		309388	389	599
Breitenkürzung € 40					
Inneres hängendes Schubkastenelement mit 2 Schublade (inklusive Abdeckplatte/Struktur-Einlegeboden) 	43,7 cm		309391	303	413
	47,7 cm		309392	303	413
	57,3 cm		309394	331	466
	90 cm		309396	412	602
	98 cm		309397	412	602
	117,2 cm		309398	453	671
Breitenkürzung € 70					
Schräge Fachböden als Schuhablage für Schrankinnenraum 	43,7 cm		319003I	97	135
	47,7 cm		319005I	97	135
	57,3 cm		319007I	101	142
	90 cm		319011I	114	189
	98 cm		319014I	114	189
	117,2 cm		319018I	135	208







56 Die Innenlackierung der Module, Seitenwände und Trennwände basiert auf der Ausführung Canvas

Typen- und Preisliste

INNENAUSSTATTUNG

MT Ausführungen Rau: CNV Canvas / NAM Nussbaum Bernstein / YUT Yuta / LIN Leinen

Die Einlegeböden sind auch in T. 42 cm erhältlich, ohne Aufpreis.

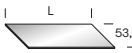
			STOFFOPTIK / ALPACA	LACKIERT OC	
			Für Abteil B.	Art.-Nr.	
Innere Einlegeböden St. 4 cm					
		43,7 cm	309003	57	100
		47,7 cm	309005	57	100
		57,3 cm	309007	61	107
		90 cm	319011	76	160
		98 cm	319014	76	160
		117,2 cm	319018	84	181
		136,2 cm	319021	100	220
	Abschlussmodul RE	38,2 cm	309025	71	105
	Abschlussmodul LI	38,2 cm	309025	71	105
	Eckmodul	105,5 cm	309023	181	393
Innere Einlegeböden St. 2,5 cm					
		43,7 cm	309003E	52	91
		47,7 cm	309005E	52	91
		57,3 cm	309007E	56	97
		90 cm	319011E	69	145
		98 cm	319014E	69	145
		117,2 cm	319018E	77	162
		136,2 cm	319021E	91	198
	Abschlussmodul RE	38,2 cm	309025E	65	94
	Abschlussmodul LI	38,2 cm	309025E	65	94
	Eckmodul	105,5 cm	309023E	162	356
Innere Einlegeböden aus "Rauchglas" Stärke 8 mm					
		43,7 cm	309083	45	
		47,7 cm	309085	93	
		57,3 cm	309087	108	
		90 cm	309091	154	
		98 cm	309094	164	

Die Innenlackierung der Module, Seitenwände und Trennwände basiert auf der Ausführung Canvas

57

INNENAUSSTATTUNG

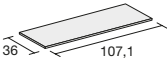
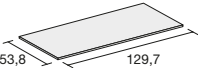
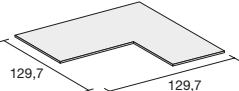
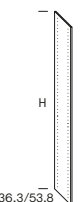

MT Ausführungen Rau: CNV Canvas / NAM Nussbaum Bernstein / YUT Yuta / LIN Leinen

Die Einlegeböden sind auch in T. 42 cm erhältlich, ohne Aufpreis.

	Für Abteil B.	Art.-Nr.	STOFFOPTIK / ALPAGA	LACKIERT OC	
<p>Innerer Einlegeboden St. 4 für Schrankkabine 2 Türen</p> 	107 cm	319045	85	148	
<p>Innerer Einlegeboden St. 4 für Schrankkabine 2 Türen 45°</p> 	129,7 cm	319046	112	226	
<p>Innerer Eck-Einlegeboden St. 4 für Schrankkabine 2 Türen 45°</p> 	129,7 x 129,7 cm	319047	240	491	
 <p>Innere Zwischenwand für Modul mit Schiebetür 2,5 cm</p> <p>Trennwand nach Maß für Innenraum mit Schiebetür</p> <p>ANM.: Für eine garantierte Stabilität sind mindestens 3 Einlegeböden einzusetzen. Nicht für Aufsatz auf Schubladenelementen erhältlich.</p>	H. Max H.	117,7 cm 181,7 cm 270 cm	309516 309518 309520	56 76 146	155 227 348
 <p>Innere Zwischenwand für Modul mit Schiebetür 2,5 cm</p> <p>Trennwand nach Maß für Innenraum mit Drehtür</p> <p>ANM.: Für eine garantierte Stabilität sind mindestens 3 Einlegeböden einzusetzen. Nicht für Aufsatz auf Schubladenelementen erhältlich.</p>	H. Max H.	122,2 cm 186,2 cm 280,5 cm	309511 309513 309521	56 76 146	155 227 348

58 Die Innenlackierung der Module, Seitenwände und Trennwände basiert auf der Ausführung Canvas

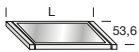
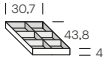
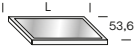
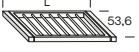
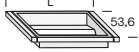
INNENAUSSTATTUNG

	Für Abteil B.	Art.-Nr.	€
Ausziehbarer Einsatz aus "Rauchglas" 	43,7 cm	309103	347
	47,7 cm	309105	347
	57,3 cm	309107	362
	90 cm	309111	430
	98 cm	309114	430
	117,2 cm	309118	467
Trennelement für ausziehbaren Einsatz als Extra 		309920	180
Fixer Einlegeboden mit Beleuchtung aus "Rauchglas" 	43,7 cm	309183	381
	47,7 cm	309185	381
	57,3 cm	309187	386
	90 cm	309191	477
	98 cm	309194	477
	117,2 cm	309198	534
	1-Weg-Transformator 30 W - 230 V		58
2-Weg-Transformator 70 W - 230 V		112	
1-Weg-Transformator 30 W - 110 V		107	
2-Weg-Transformator 70 W - 110 V		164	
Die Nutzung ist mit einer direkt an das Netzwerk angeschlossenen Steckdose vorgesehen.			
Ausziehbarer Hosenhänger, Stangen aus Aluminium 	43,7 cm	309143	360
	47,7 cm	309145	360
	57,3 cm	309147	387
	90 cm	309151	513
	98 cm	309154	513
	117,2 cm	309158	568
Aufpreis für einzelne Hosenhängerstange		€ 12	
Ausziehbare Schuhablage 	57,3 cm	309167	374
	90 cm	309171	415
	98 cm	309174	415
	117,2 cm	309178	455
Kleiderlift mit Halterungen (Tragfähigkeit max. 10 kg) 	90 / 98 / 117,2 cm	309930	255
Nicht für Abteil B. 136,2 lieferbar			

Die Innenlackierung der Module, Seitenwände und Trennwände basiert auf der Ausführung Canvas

59

INNENAUSSTATTUNG

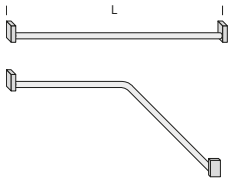
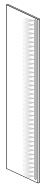
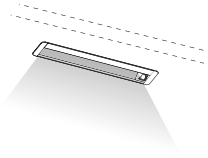
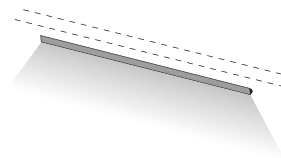
Alle Leuchten 3000 K		Für Abteil B.	Art.-Nr.	€
Runde Kleiderstange				
	43,7 cm		309901	12
	47,7 cm		309902	12
	57,3 cm		309904	12
	90 cm		309906	16
	98 cm		309907	16
	117,2 cm		309908	24
	136,2 cm		309909	25
	Eckmodul		309913	43
Seitliche Beleuchtung für Trennwand und Seitenwa				
	223 cm		309944	208
	239 cm		309945	218
	255 cm		309942	227
	287 cm		309943	249
	1-Weg-Transformator 30 W - 230 V			58
	2-Weg-Transformator 70 W - 230 V			112
	1-Weg-Transformator 30 W - 110 V			107
	2-Weg-Transformator 70 W - 110 V			164
Nicht für Module mit Schublade und/oder Schubkasten Modula oder Seitenwand für Abschlussmodule erhältlich.				
LED-Lampe Capri mit integriertem Sensor B. 19,5 (Ausführung grau)				
			309940	107
			Transformator 230 V (max. 6 Kanäle)	58
			Transformator 110 V (max. 6 Kanäle)	107
ANM.: Auf der Abdeckung und/oder dem Einlegeboden vormontiert				
LED-Lampe Vela für offene Schrankkabine				
	W 3,8	43,7 cm	309941V	57
	W 3,8	47,7 cm	309941V	57
	W 5,32	57,3 cm	309942V	65
	W 9,12	90 cm	309944V	83
	W 9,12	98 cm	309944V	83
	W 12,16	117,2 cm	309946V	104
	W 14,44	136,2 cm	309948V	114
	Nur für 230 V		Transformator 30 W	58
	Nur für 230 V		Transformator 70 W	112
	Nur für 110 V		Transformator 30 W	107
	Nur für 110 V		Transformator 70 W	164
Für Abteile mit Türen ist pro Abteil ein Sensor € 59,66 hinzuzufügen				

⁶⁰ * Die Nutzung ist mit einer direkt an das Netzwerk angeschlossenen Steckdose vorgesehen.

Typen- und Preisliste

INNENAUSSTATTUNG

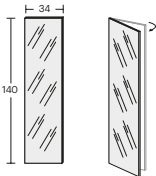
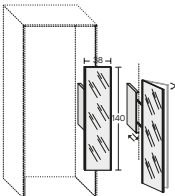
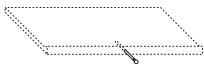
	Art.-Nr.	€
<p>Fixer Innenspiegel (zur Befestigung auf der Tür)</p> 	309935	52
<p>Schwenkbarer Innenspiegel (zur Befestigung auf der Tür)</p> 	309937	181
<p>Ausziehbarer und schwenkbarer Spiegel ST. 60 (zur Befestigung auf der Seitenwand)</p>  <p>ANM.: Nur für Schrank mit Schiebetür oder offene Schrankkabin</p>	309938	445
<p>Ausziehbarer Kleiderbügelhalter auf der Vorderseite des Einlegebodens (vormontiert)</p> 	309933	26
<p>Scharniere mit 180°-Öffnung</p>		12

AUFPREISE FÜR BELEUCHTUNG TÜREN **DORIS - ATHENA**

Einschalten der Beleuchtung durch Kontakt mit dem Anschlussstecker.
Die Nutzung ist mit einer direkt an das Netzwerk angeschlossenen Steckdose vorgesehen.

€

LED-Leuchte für Tür ATHENA (pro Tür)

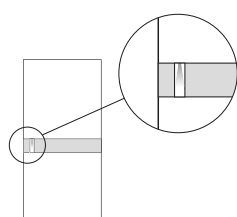

inklusive Netzgerät 36 W kann mit dem Schalter
der vorhandenen Elektroanlage verwendet werden

129

Netzgerät mit Fernbedienung 36 W (nur für 230V)

+ 187

LED-Leuchte für Tür DORIS 13,6w (pro Tür)

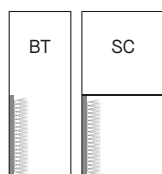

inklusive Netzgerät 36 W kann mit dem Schalter
der vorhandenen Elektroanlage verwendet werden

246

ZUSCHNITTE NACH MASS BEI MODULEN - SMART

FOLGENDE ELEMENTEN WERDEN NICHT GEKÜRZT:

- Ausziehbare Zubehörteile
- Rückwände unter Brückenmodulen
- Schrankkabinen mit 2 und 3 Türen
- Glaseinlegeböden
- Offenes Abteil und Schubladen
- Abschlussmodule
- Modula mit Schubladen
- Innere Schubladenelemente in der Tiefe

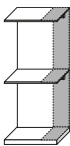
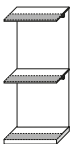
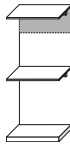
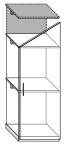
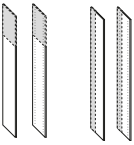
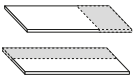
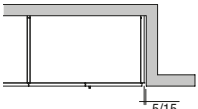
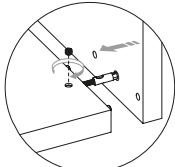
CORTES SOLO ESTRUCTURAS		ACHTUNG: Der Aufpreis beinhaltet nicht die Kürzung der Seitenwände und Trennwände		Aufpreis
	BREITENKÜRZUNG bei einem Modul		pro Stück	+ 65
	TIEFENKÜRZUNG bei einem Modul		pro Stück	+ 49
	HÖHENKÜRZUNG bei einem Modul	B. 43,7 - 47,7 - 57,3 - 90 - 98 - 117,2 cm	pro Stück	+ 16
		B. 136,2 cm	pro Stück	+ 32
	Kürzung für SCHRÄGEN ZUSCHNITT IN DER HÖHE bei einem Modul mit 1 Tür (Der schräge Zuschchnitt wird nur bei der Tür durchgeführt. Die Struktur wird stufenförmig zugeschnitten) Die Module sind immer einzeln und die Scharniere der Türen liegen auf der höheren Seite.	Tür LISCIA		+ 130
		Tür GOLA		+ 178
KÜRZUNG SEITENWAND UND TRENNWAND				
	HÖHEN- oder TIEFENKÜRZUNG und/oder Versetzung der Bohrlöcher bei einer Seitenwand oder Trennwand ANM.: Bei Logica ist die Höhenkürzung nicht unter 2 cm und höchstens bis 7 cm durchführbar		pro Stück	+ 16
KÜRZUNG HOLZEINLEGEBODEN				
	BREITEN- oder TIEFENKÜRZUNG		pro Stück	+ 16
		Aufpreis für Vorbereitungen für Nischenmontage	1 modul 15 mm	+ 54

PASSLEISTEN

SEITLICHE PASSLEISTE RECHTS ODER LINKS

OBERE PASSLEISTE

ANM: Diese werden mit Bohrlöchern geliefert und ermöglichen dadurch eine rasche Montage.

HÖHE MAX. 290 CM

LÄNGE MAX. 291 CM

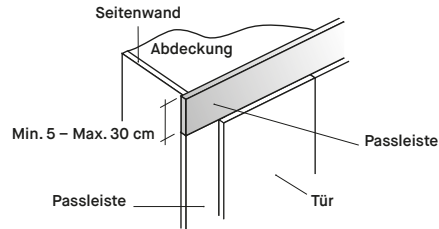
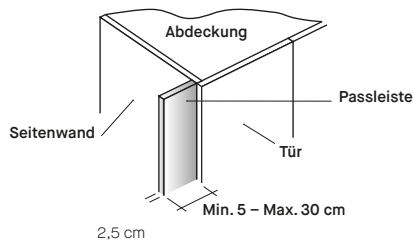

ANM.: (Mindestpreis für 2 Laufmeter)

St. 2,5

St. 3

Von 5 bis 14,9 cm pro Laufmeter

0296327A

0296329A

MT OC (BG-MP-ARN-BA-MA-AN) MT PA (BG-MP) MT RC / MT RSB MT RMK MT RNC / MT RNN MT CC / MT CV MT CLC / MT CLS MT ALP / MT OBR	LACKIERT OC-PA	LACKIERT OCM	LACKIERT LC
---	----------------	--------------	-------------

66

132

159

159

Von 15 bis 30 cm pro Laufmeter

0296327B

0296329B

115

250

301

301

AUFPREIS FÜR LACKIERUNG NACH MUSTER UND HÄNGEVORRICHTUNGEN

€

Sämtliche Elemente, die in der Preisliste in Ausführung matt, offenporig oder glänzend lackiert angeboten werden, sind auch mit „LACKIERUNG NACH MUSTER“ lieferbar (nur laut Farbkarte RAL)

30%

Hängevorrichtung für die Wandbefestigung

+ 54

PANEELE NACH MASS

€/m²

Art.-Nr.

St. 1,4
0296302

St. 2
0296305

St. 2,5
0296307

St. 3
0296309

H. max.: 200 cm
St. 1,4/2/2,5/3 cm
MT RSB / MT RC MT RMK /
MT PA / PA
MT CC / MT CV / MT CLC
MT CLS / MT RNC
MT RNN / MT ALP
MT OBR / MT OC / OC

H. max.: 275 cm
St. 2/2,5 cm MT
H. max.: 290 cm
St. 1,4/3 cm MT
H. max.: 300 cm
St. 1,4/2/3 cm MT OC / MT PA
OC / PA / OCM

MT OC (BG-MP-ARN-BA-MA-AN) / MT PA (BG-MP)
MT RC / MT RSB / MT RMK / MT RNC / MT RNN
MT CC / MT CV / MT CLC / MT CLS / MT ALP / MT OBR

97

104

110

129

Panel lackiert, 1 Seite ausgefertigt
LACKIERT OC-PA
LACKIERT OCM

168

174

181

200

201

209

216

240

Panel lackiert, 2 Seiten ausgefertigt
LACKIERT OC-PA
LACKIERT OCM

239

246

252

270

287

294

302

324

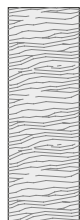

Länge: min. 5 cm – max. 120 cm

ANM.: Wo vorgesehen, immer die Richtung der Maserung angeben.

Mindestpreis: 1 m²

PASSLEISTEN

LÖSUNG **A**

Innere Passleiste.

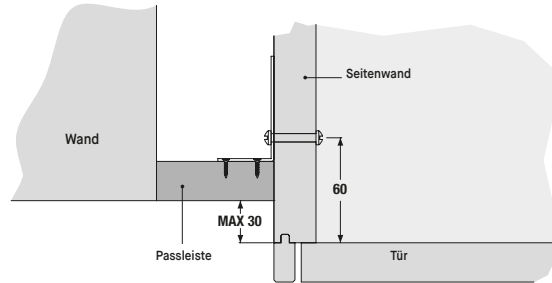

LÖSUNG **B**

Passleiste für innere komplanare Tür.

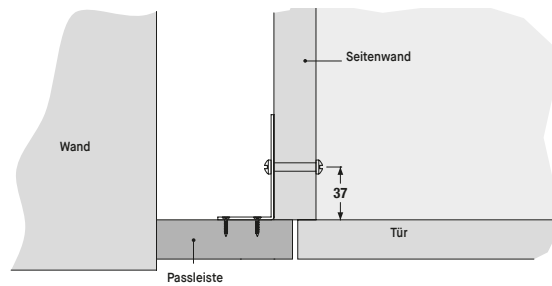

LÖSUNG **C**

Passleiste für flächenbündige komplanare Tür.

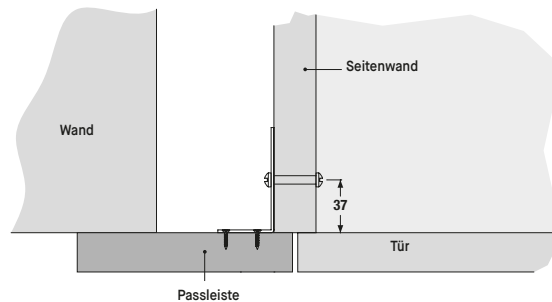

LÖSUNG **B / C**

Lösung "c" und "d" auch mit Trennwand lieferbar.

Einsatzbeispiel für Passleiste als Türanschlag (nicht inbegriffen).
Siehe dazu den Grafikentwurf.

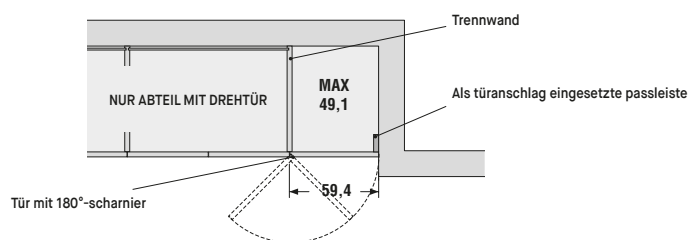

Ausführungen

MT PREMIUM Rau offenporig lackiert

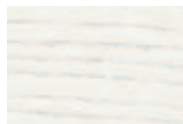

MT PA BG
Gipsweiß

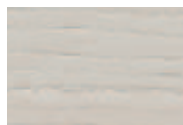

MT PA MP
Perlmutter

MT PREMIUM Rau Texture



MT ALP
Alpaca

MT PREMIUM Rau matt



MT OC BG
Gipsweiß



MT OC MP
Perlmutter



MT OC ARN
Arena



MT OC BA
Basaltgrau



MT OC MA
Mergel



MT OC AN
Anthrazit

MT PREMIUM Rau Zement



MT CC
Zement hell



MT CV
Zement Cava



MT CS
Zement dunkel

MT PREMIUM Rau Kalk



MT CLC
Kalk hell



MT CLS
Kalk dunkel

MT PREMIUM Rau Holz



MT RSB
Eiche Sand



MT RMK
Eiche Mokka



MT RC
Eiche Kohlegrau

MT PREMIUM Rau astig



MT RNN
Astig Natur







MT RNC
Astig hell







MT RNS
Astig dunkel

Typen- und Preisliste











MT SPECIAL Rau	
	MT PB Stroh Bronze
	MT PG Stroh Grau
	MT MB Maya Bronze
	MT OBR Oxid brüniert
	MT INT C Geflecht hell



LACKIERUNGEN 1/ONE OC	
	OC BG Gipsweiß
	OC MP Perlmutter
	OC ARN Arena
	OC BA Basaltgrau

BEST SELLER Matt	
	BS OC BG Gipsweiß
	BS OC MP Perlmutter
	BS PA BG Gipsweiß
	BS PA MP Perlmutter



METALLIC-LACKIERUNG	
	OCM 090 Bronzeoptik
	OCM 091 Ghisa
	OCM 092 Messing

Ausführungen



SPIEGEL		HOLZ	
	383 Grauer Spiegel		LGN RSB Eiche Sand
	382 Spiegel in Bronzeoptik		LGN RMK Eiche Mokka
	381 Spiegel in Silberoptik		LGN RC Eiche Kohlegrau
			LGN RNN Astig Natur
			LGN RNC Astig hell
			LGN RNS Astig dunkel
			LGN NAM Nussbaum Bernstein

GLAS	
	320 Transparentes Glas
	Rauchglas

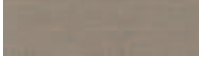
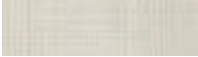
SC HRANKINNENRÄUME - AUSFÜHRUNGEN SMART

















	
	
Rau Alpaca	Rau Stoffoptik

SC HRANKINNENRÄUME - AUSFÜHRUNGEN OC



In Farbe matt lackiert auf Basis Canvas

Ausführungen

Die Ausführungen und Farben sind rein hinweisend und können je nach Drucktechnik leichte Abweichungen aufweisen.

				
	Gipsweiß	Platin	Perlmutter	Hanfbeige
Matt lackiert	121	162	124	150
Glänzend lackiert	121	162	124	150
Offenporig	221	262	224	250
Glänzendes Glas	321	362	324	350
Glänzendes Glas	421	462	424	450
				
	Hot Grau	Arena	Gris Piacenza	Schlamm
Matt lackiert	127	178	130	161
Glänzend lackiert	127	178	130	161
Offenporig	227	278	230	261
Glänzendes Glas	327	378	330	361
Glänzendes Glas	427	478	430	461
				
	Bimsstein	Salzgrau	Rauchgrau	Lava
Matt lackiert	152	163	174	175
Glänzend lackiert	152	163	174	175
Offenporig	252	263	274	275
Glänzendes Glas	352	363	374	375
Glänzendes Glas	452	463	474	475
				
	Smoke	Anthrazit	Schiefergrau	Schwarz
Matt lackiert	128	160	164	131
Glänzend lackiert	128	160	164	131
Offenporig	228	260	264	231
Glänzendes Glas	328	360	364	331
Glänzendes Glas	428	460	464	431

Typen- und Preisliste

Beispiel mit Perlmutt



124
Cod. 100
für matte und glänzende
Lackierungen



224
Cod. 200
für offenporige
Lackierungen



324
Cod. 300
glänzende Gläser



424
Cod. 400
satinierter Gläser



Eis



Basaltgrau



Bromo



Pastellblau

Matt lackiert	173
Glänzend lackiert	173
Offenporig	273
Glänzendes Glas	373
Glänzendes Glas	473

177
177
277
377
477

176
176
276
376
476

155
155
255
355
455



Mimetec Grün



Onyx



Myrte



Waldgrün

Matt lackiert	166
Glänzend lackiert	166
Offenporig	266
Glänzendes Glas	366
Glänzendes Glas	466

167
167
267
367
467

165
165
265
365
465

168
168
268
368
468



Mergel



Preußischblau



Donaublau



Salbeigrün

Matt lackiert	180
Glänzend lackiert	180
Offenporig	280
Glänzendes Glas	380
Glänzendes Glas	480

181
181
281
381
481

182
182
282
382
482

159
159
259
359
459



Kurkuma



Safrangelb



Terracotta



Pfirsich

Matt lackiert	169
Glänzend lackiert	169
Offenporig	269
Glänzendes Glas	369
Glänzendes Glas	469

158
158
258
358
458

170
170
270
370
470

157
157
257
357
457



Rubinrot



Tabasco



Bordeaux

Matt lackiert	172
Glänzend lackiert	172
Offenporig	272
Glänzendes Glas	372
Glänzendes Glas	472

171
171
271
371
471

156
156
256
356
456

SCHRANKKABINEN

INHALTSVERZEICHNIS



PRATICO

MODULÜBERSICHT



BREITEN UND TIEFEN

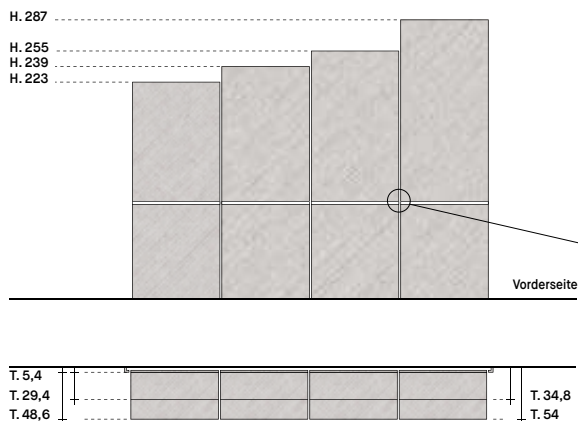

Tatsächliche Höhe einschließlich der Füße:
 - für Modul 223 Gesamthöhe H. 223,8 cm
 - für Modul 239 Gesamthöhe H. 239,8 cm
 - für Modul 255 Gesamthöhe H. 255,8 cm
 - für Modul 287 Gesamthöhe H. 287,8 cm

Toleranzgrenzen für die Montage: seitlich + 1 cm, Höhe + 3 cm

ANM.: Im Falle von nebeneinander liegenden Ausstattungen sind die Kosten für eine Halterung von einem der beiden Elemente abzuziehen. ANM.: Neben dem schrägen Fachboden kann nur ein weiterer schräger Fachboden eingesetzt werden, andere Ausstattungselemente sind versetzt anzuordnen.

PRATICO

MODULÜBERSICHT

BREITE

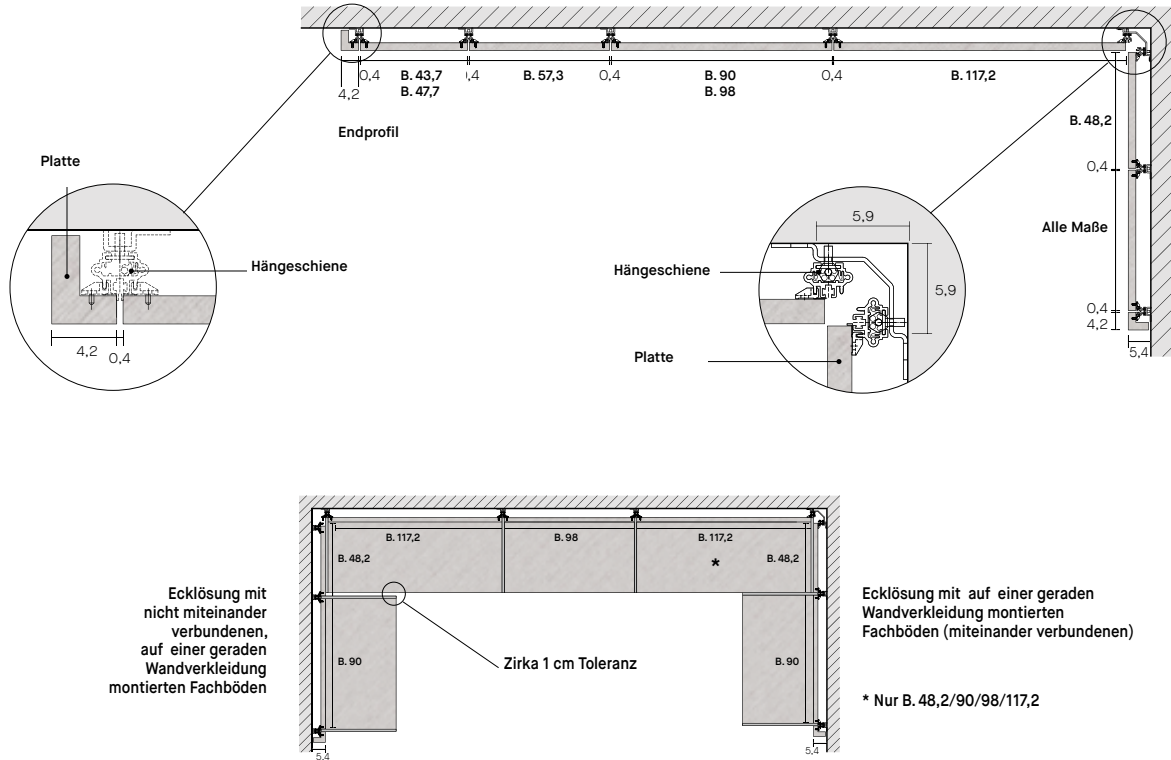

















Lieferbare Ausstattung für Wandverkleidung PRATICO

	B. 43,7	B. 47,7	B. 57,3	B. 90	B. 98	B. 117,2
Holzfachboden T 29,4 / 48,6	✓	✓	✓	✓	✓	✓
Étagère bois inclinée T 48,6	✓	✓	✓	✓	✓	✓
Podest T 48,6	✓	✓	✓	✓	✓	✓
Bodenstehendes Schubladenelement (2-3-4-5-6 Schubladen)	✓	✓	✓	✓	✓	✓
Wandhängendes Schubladenelement (1- 2 Schubladen)	✓	✓	✓	✓	✓	✓
Element Raster als Aufsatz				✓	✓	✓
Element Raster wandhängend				✓	✓	✓
Fachboden mit 1 ausziehbarem Tablett	✓	✓	✓	✓	✓	✓
Fachboden mit 2 ausziehbaren Tablett	✓	✓	✓	✓	✓	✓
Hosenhänger für ausziehbares Tablett	✓	✓	✓	✓	✓	✓
Schuhablage für ausziehbares Tablett	✓	✓	✓	✓	✓	✓
Glasfachboden für ausziehbares Tablett	✓	✓	✓	✓	✓	✓

PRATICO

WANDVERKLEIDUNG

MT 1/ONE Rau  MT CNV Canvas  MT NAM Nussbaum Bernstein		MT PREMIUM Rau  MT OC BG Gipsweiß  MT OC MP Perlmutter  MT OC ARN Arena  MT OC BA Basaltgrau  MT CC Zement hell  MT CV Zement Cava  MT CS Zement dunkel  MT RNC Astig hell  MT FO Esche Oriente  MT RSB Eiche Sand  MT RMK Eiche Mokka  MT RT Thermoeiche  MT RC Eiche Kohlegrau  MT ALP Alpaca							OC Lackierungen  OC Matt
---	--	---	--	--	--	--	--	--	--

B. 43,7 cm ST. 1,4 cm
Wandverkleidung



H	223	239	255	287
Art.-Nr.	3910201	3910401	3910601	3910801
MT 1/ONE	87			91
MT PREMIUM	132			144
OC LACKIERT	195			212
m ²	0,04	0,04	0,04	0,04
Kg	10,21	10,94	11,67	13,13

B. 47,7 cm ST. 1,4 cm
Wandverkleidung





H	223	239	255	287
Art.-Nr.	3910203	3910403	3910603	3910803
MT 1/ONE	90			96
MT PREMIUM	142			155
OC LACKIERT	207			226
m ²	0,04	0,04	0,04	0,05
Kg	11,14	11,94	12,74	14,34

B. 57,3 cm ST. 1,4 cm
Wandverkleidung



H	223	239	255	287
Art.-Nr.	3910205	3910405	3910605	3910805
MT 1/ONE	99			107
MT PREMIUM	162			176
OC LACKIERT	239			262
m ²	0,05	0,05	0,05	0,06
Kg	13,38	14,34	15,30	17,22

 Aufpreis für Breitenkürzung +15	 Aufpreis für Höhenkürzung +15
---	---

B. 31 cm ST. 0,4 cm
Fixer Spiegel

H	150
Art.-Nr.	309935
Spiegel in Silberoptik	55
m ³	0,01
Kg	5,14

Typen- und Preisliste

PRATICO

WANDVERKLEIDUNG

MT 1/ONE Rau



MT CHV
Canvas



MT NAM
Nussbaum
Bernstein

MT PREMIUM Rau



MT OC BG
Gipsweiß



MT OC MP
Perlmutter



MT OC ARN
Arena



MT OC BA
Basaltgrau



MT CC
Zement hell



MT CV
Zement Cava



MT CS
Zement dunkel



MT RNC
Astig hell



MT FO
Esche Oriente



MT RSB
Eiche Sand



MT RMK
Eiche Mokka



MT RT
Thermoeiche



MT RC
Eiche Kohlegrau



MT ALP
Alpaca

OC Lackierungen



OC
Matt

B. 90 cm ST. 1,4 cm Wandverkleidung



H	223	239	255	287
Art.-Nr.	3910209	3910409	3910609	3910809
MT 1/ONE		130		140
MT PREMIUM		226		249
OC LACKIERT		349		385
m³	0,07	0,08	0,08	0,09
Kg	21,02	22,53	24,03	27,05

B. 98 cm ST. 1,4 cm Wandverkleidung



H	223	239	255	287
Art.-Nr.	3910211	3910411	3910611	3910811
MT 1/ONE		138		148
MT PREMIUM		243		265
OC LACKIERT		378		415
m³	0,08	0,08	0,09	0,10
Kg	22,89	24,53	26,17	29,45

B. 117,2 cm ST. 1,4 cm Wandverkleidung



H	223	239	255	287
Art.-Nr.	3910213	3910413	3910613	3910813
MT 1/ONE		156		168
MT PREMIUM		282		310
OC LACKIERT		440		487
m³	0,10	0,10	0,10	0,12
Kg	27,37	29,33	31,3	35,22

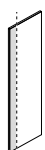

Aufpreis für
Breitenkürzung

+15



Aufpreis für
Höhenkürzung

+15

B. 31 cm ST. 0,4 cm Fixer Spiegel

H	150
Art.-Nr.	309935
Spiegel in Silberoptik	55
m³	0,01
Kg	5,14

PRATICO

WANDVERKLEIDUNG GRAPHIC

Für Ausführungen Graphic siehe Seite 9

ST. 1,4 cm
Wandverkleidung Graphic

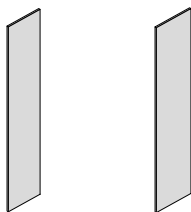

		H	223	239	255	287
		Art.-Nr.	3910201	3910401	3910601	3910801
GRAPHIC	B. 43,7		207			226
		m ³	0,04	0,04	0,04	0,04
		Kg	10,21	10,94	11,67	13,13
		Art.-Nr.	3910203	3910403	3910603	3910803
GRAPHIC	B. 47,7		221			244
		m ³	0,04	0,04	0,04	0,05
		Kg	11,14	11,94	12,74	14,34

ST. 1,4 cm
Wandverkleidung Graphic

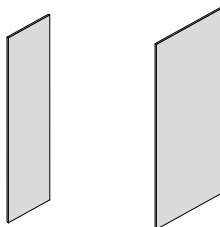

		H	223	239	255	287
		Art.-Nr.	3910205	3910405	3910605	3910805
GRAPHIC	B. 57,3		255			281
		m ³	0,05	0,05	0,05	0,06
		Kg	13,38	14,34	15,30	17,22
		Art.-Nr.	3910209	3910409	3910609	3910809
GRAPHIC	B. 90		372			413
		m ³	0,07	0,08	0,08	0,09
		Kg	21,02	22,53	24,03	27,05

ST. 1,4 cm
Wandverkleidung Graphic

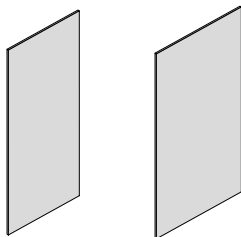

		H	223	239	255	287
		Art.-Nr.	3910211	3910411	3910611	3910811
GRAPHIC	B. 98		401			445
		m ³	0,08	0,08	0,09	0,10
		Kg	22,89	24,53	26,17	29,45
		Art.-Nr.	3910213	3910413	3910613	3910813
GRAPHIC	B. 117,2		472			522
		m ³	0,10	0,10	0,10	0,12
		Kg	27,37	29,33	31,30	35,22

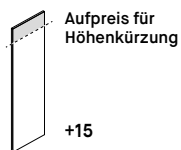

B. 31 cm ST. 0,4 cm
Fixer Spiegel

		H	150
		Art.-Nr.	309935
Spiegel in Silberoptik			54
		m ³	0,01
		Kg	5,14

Typen- und Preisliste

PRATICO

WANDVERKLEIDUNG GRAPHIC



1010



1011



1020



1021



1030



1031



1040



1041



1050



1051



1060



1061



1070



1071



1080



1081



1090



1091



1100



1101



1102



1103



















1104



1105

PRATICO

ECK-WANDVERKLEIDUNG

MT 1/ONE Rau  MT CNV Canvas  MT NAM Nussbaum Bernstein		MT PREMIUM Rau  MT OC BG Gipsweiß  MT OC MP Perlmutter  MT OC ARN Arena  MT OC BA Basaltgrau  MT CC Zement hell  MT CV Zement Cava  MT CS Zement dunkel  MT RNC Astig hell  MT FO Esche Oriente  MT RSB Eiche Sand  MT RMK Eiche Mokka  MT RT Thermoeiche  MT RC Eiche Kohlegrau  MT ALP Alpaca							OC Lackierungen  OC Matt
---	--	---	--	--	--	--	--	--	--

B. 48,2 cm ST. 1,4 cm
Eck-Wandverkleidung

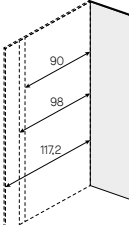

	H	223	239	255	287
Art.-Nr.		3910219	3910419	3910619	3910819
MT 1/ONE			90		96
MT PREMIUM			142		155
OC LACKIERT			207		226
m ²		0,04	0,04	0,04	0,05
Kg		11,26	12,06	12,87	14,49

Eck-Hängeschiene



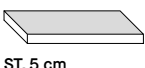

	H	223	239	255	287
Art.-Nr.		3913312	3913314	3913316	3913318
Für Wandverkleidung			198		210
	H	223	239	255	287
Art.-Nr.		3913312L	3913314L	3913316L	3913318L
Für Wandverkleidung mit Elektroanschluss			335		363
m ²		0,01	0,01	0,01	0,01
Kg		1,11	1,19	1,27	1,43

B. 48,2 cm
Fachböden und Podest für Eck-Wandverkleidung

 **ST. 3 cm**
 **ST. 5 cm**

	Art.-Nr.	Fachboden	Fachboden	Kleiderstange	Podeste
		3916419	3916439	3919319	3916339
MT 1/ONE		88			112
MT PREMIUM	T. 29,4	95	T. 48,6	+17	T. 48,6
OC LACKIERT		114			156
LED-Beleuchtung als Extra		+ 93	+ 93	-	-
m ²		0,01	0,01	0,01	0,02
Kg		3,15	5,2	0,31	8,67

 Aufpreis für Breitenkürzung + 17	 Aufpreis für Höhenkürzung + 17	 Aufpreis für Kürzung der Eck-Hängeschiene + 33
--	--	--

Typen- und Preisliste

PRATICO

PROFILE FÜR WANDVERKLEIDUNG

MT 1/ONE Rau



MT CHV
Canvas



MT NAM
Nussbaum
Bernstein

MT PREMIUM Rau



MT OC BG
Gipsweiß



MT OC MP
Perlmutter



MT OC ARN
Arena



MT OC BA
Basaltgrau



MT CC
Zement hell



MT CV
Zement Cava



MT CS
Zement dunkel



MT RNC
Astig hell



MT FO
Esche Oriente



MT RSB
Eiche Sand



MT RMK
Eiche Mokka



MT RT
Thermoeiche



MT RC
Eiche Kohlegrau



MT ALP
Alpaca

OC Lackierungen



OC
Matt

Hängeschiene



H	223	239	255	287
Art.-Nr.	3913302	3913304	3913306	3913308
Für Wandverkleidung	95			100
H	223	239	255	287
Art.-Nr.	3913302L	3913304L	3913306L	3913308L
Für Wandverkleidung mit Elektroanschluss	163			177
m³	0,01	0,01	0,01	0,01
Kg	1,11	1,19	1,27	1,43

Endprofil RECHTS/LINKS

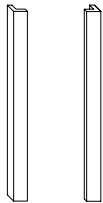

H	223	239	255	287
Codice SX Codigo IZDA	3913202S	3913204S	3913206S	3913208S
Codice DX Codigo DCHA	3913202D	3913204D	3913206D	3913208D
MT 1/ONE	64			65
MT PREMIUM	87			94
OC LACKIERT	147			162
m³	0,01	0,01	0,01	0,01
Kg	2,24	2,40	2,56	2,89

B. Von 6 bis 30 cm

Pfosten mit seitlicher Passeleiste (einschließlich Befestigung)

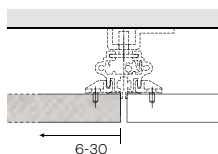

H	223	239	255	287
Art.-Nr.	3913202	3913204	3913206	3913208
MT 1/ONE	161			171
MT PREMIUM	194			207
OC LACKIERT	234			256
m³	0,01	0,01	0,01	0,01
Kg	3,35	3,59	3,83	4,26

Aufpreis für
Kürzung der
Hängeschiene

+ 17



Aufpreis für Kürzung des
Abschlussprofils



+ 17



PRATICO

FACHBÖDEN T 29,4



MT 1/ONE
Rau

MT CNV
Canvas

MT NAM
Nussbaum
Bernstein







Metallausführungen

Anthrazit

Gris

MT PREMIUM
Rau

MT OC BG
Gipsweiß

MT OC MP
Perlmutter







MT OC ARN
Arena

MT OC BA
Basaltgrau

MT CC
Zement hell

MT CV
Zement Cava

MT CS
Zement dunkel

MT RNC
Astig hell

MT FO
Esche Oriente

MT RSB
Eiche Sand

MT RMK
Eiche Mokka

MT RT
Thermoeiche

MT RC
Eiche Kohlegrau

MT ALP
Alpaca

OC
Lackierungen



OC
Matt

T. 29,4 cm ST. 3 cm
Fachboden



	H	Fachboden	Fachboden
	Art.-Nr.	3916401	3916403
MT 1/ONE		85	88
MT PREMIUM	B. 43,7	89	B. 47,7 95
OC LACKIERT		109	114
LED-Beleuchtung als Extra		+ 90	+ 93
	m ³	0,01	0,01
	Kg	2,88	3,15

T. 29,4 cm ST. 3 cm
Fachboden



	H	Fachboden	Fachboden
	Art.-Nr.	3916405	3916409
MT 1/ONE		89	96
MT PREMIUM	B. 57,3	97	B. 90 106
OC LACKIERT		122	145
LED-Beleuchtung als Extra		+ 100	+ 124
	m ³	0,01	0,01
	Kg	3,78	5,94

T. 29,4 cm ST. 3 cm
Fachboden



	H	Fachboden	Fachboden
	Art.-Nr.	3916411	3916413
MT 1/ONE		99	104
MT PREMIUM	B. 98	112	B. 117,2 119
OC LACKIERT		68	167
LED-Beleuchtung als Extra		+ 127	+ 145
	m ³	0,02	0,02
	Kg	6,47	7,73

ANM.: Die Fachböden werden mit Abschluss-Halterungen berechnet. Für Halterungen, Kleiderbügelhalter die Ausführung Anthrazit oder Gris angeben.

Die Fachböden mit LED-Beleuchtung müssen immer mit der Hängeschiene mit Elektroanschluss kombiniert werden.

Ausziehbarer Kleiderbügelhalter auf der Vorderseite des Fachbodens (vormontiert)

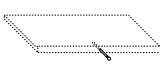

Art.-Nr.	309933
ANTHRAZIT	17
GRIS	
m ³	0,01
Kg	0,08

82 Hinsichtlich der Vorgaben für den Einsatz der LED-Beleuchtung (muss immer mit einem Transformator ergänzt werden) siehe Seite 30

Typen- und Preisliste

PRATICO

FACHBÖDEN T 48,6

MT 1/ONE Rau  MT CHV Canvas  MT NAM Nussbaum Bernstein	MT PREMIUM Rau  MT OC BG Gipsweiß  MT OC MP Perlmutter  MT OC ARN Arena  MT OC BA Basaltgrau  MT CC Zement hell  MT CV Zement Cava  MT CS Zement dunkel	OC Lackierungen  OC Matt
Metallausführungen  Anthrazit  Gris	 MT RNC Astig hell  MT FO Esche Oriente  MT RSB Eiche Sand  MT RMK Eiche Mokka  MT RT Thermoeiche  MT RC Eiche Kohlegrau  MT ALP Alpaca	

T. 48,6 cm ST. 3 cm Fachboden

	H	Fachboden	Kleiderstange	Fachboden	Kleiderstange
	Art.-Nr.	3916421	3919301	3916423	3919303
MT 1/ONE		89		93	
MT PREMIUM	B. 43,7	99	+ 36	B. 47,7	+ 37
OC LACKIERT		132		135	
LED-Beleuchtung als Extra		+ 90	-	+ 93	-
	m ³	0,01	0,01	0,01	0,01
	Kg	4,77	0,28	5,2	0,31

T. 48,6 cm ST. 3 cm Fachboden

	H	Fachboden	Kleiderstange	Fachboden	Kleiderstange
	Art.-Nr.	3916425	3919305	3916429	3919309
MT 1/ONE		97		106	
MT PREMIUM	B. 57,3	241	+ 37	B. 90	+ 48
OC LACKIERT		148		186	
LED-Beleuchtung als Extra		+ 100	-	+ 124	-
	m ³	0,01	0,01	0,02	0,01
	Kg	5,86	0,37	9,82	0,58

T. 48,6 cm ST. 3 cm Fachboden

	H	Fachboden	Kleiderstange	Fachboden	Kleiderstange
	Art.-Nr.	3916431	3919311	3916433	3919313
MT 1/ONE		110		119	
MT PREMIUM	B. 98	128	+ 48	B. 117,2	+ 57
OC LACKIERT		196		222	
LED-Beleuchtung als Extra		+ 127	-	+ 145	-
	m ³	0,03	0,01	0,03	0,01
	Kg	10,69	0,63	12,78	0,76

ANM.: Die Fachböden werden mit Abschluss-Halterungen berechnet.
Für Halterungen, Kleiderbügelhalter und Kleiderstangen die Ausführung Anthrazit oder Gris angeben.

Die Fachböden mit LED-Beleuchtung müssen immer mit der Hängeschiene mit Elektroanschluss kombiniert werden.

Ausziehbarer Kleiderbügelhalter auf der Vorderseite des Fachbodens (vormontiert)

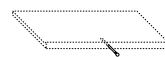

Art.-Nr.	309933
ANTHRAZIT	
GRIS	17
m ³	0,01
Kg	0,08

Hinsichtlich der Vorgaben für den Einsatz der LED-Beleuchtung (muss immer mit einem Transformator ergänzt werden) siehe Seite 30

83

PRATICO

SCHRÄGE FACHBÖDEN UND PODESTE

**MT 1/ONE
Rau**



MT CNV
Canvas



MT NAM
Nussbaum
Bernstein

Metallausführungen



Anthrazit



Gris

**MT PREMIUM
Rau**



MT OC BG
Gipsweiß



MT OC MP
Perlmutter



MT OC ARN
Arena



MT OC BA
Basaltgrau



MT CC
Zement hell



MT CV
Zement Cava



MT CS
Zement dunkel



MT RNC
Astig hell



MT FO
Esche Oriente



MT RSB
Eiche Sand



MT RMK
Eiche Mokka



MT RT
Thermoeiche



MT RC
Eiche Kohlegrau



MT ALP
Alpaca

**OC
Lackierungen**



**OC
Matt**

Schräge Fachböden



		B. 43,7	B. 47,7	B. 57,3	B. 90	B. 98	B. 117,2
Art.-Nr.		3916421I	3916423I	3916425I	3916429I	3916431I	3916433I
MT 1/ONE	T. 48,6	153	154	157	168	171	178
MT PREMIUM		161	164	169	187	192	203
OC LACKIERT		193	197	212	252	262	288
	m ³	0,01	0,01	0,01	0,02	0,03	0,03
	Kg	4,77	5,20	5,86	9,82	10,69	12,78

ST. 5 cm Podeste



		B. 43,7	B. 47,7	B. 57,3	B. 90	B. 98	B. 117,2
Art.-Nr.		3916321	3916323	3916325	3916329	3916331	3916333
MT 1/ONE	T. 48,6	109	112	116	136	139	152
MT PREMIUM		116	120	127	152	159	174
OC LACKIERT		149	156	169	219	231	259
	m ³	0,02	0,02	0,02	0,03	0,04	0,04
	Kg	7,94	8,67	10,42	16,36	17,81	21,3



ANM.: Der schräge Fachboden und das Podest werden mit Abschluss-Halterungen berechnet.
Für Halterungen die Ausführung Anthrazit oder Gris angeben.

Typen- und Preisliste

PRATICO

BODENSTEHENDE SCHUBLADENELEMENTE



MT 1/ONE
Rau

MT CHV
Canvas

MT NAM
Nussbaum
Bernstein







Metallausführungen

Anthrazit

Gris

MT PREMIUM
Rau

MT OC B6
Gipsweiß

MT OC MP
Perlmutter

MT OC ARN
Arena

MT OC BA
Basaltgrau

MT CC
Zement hell

MT CV
Zement Cava

MT CS
Zement dunkel









MT RNC
Astig hell

MT FO
Esche Oriente

MT RSB
Eiche Sand

MT RMK
Eiche Mokka

MT RT
Thermoeiche

MT RC
Eiche Kohlegrau

MT ALP
Alpaca

OC
Lackierungen



OC
Matt

Gläser



601
Gläser
Rauchglas

T. 48,6 H. 35 cm
2 Schubladen



	Art.-Nr.	Griff	Hohlkehle	Glas		Griff	Hohlkehle	Glas	
		3917001	391G7001	391V7001		3917003	391G7003	391V7003	
MT 1/ONE	B. 43,7	358	382	465	B. 47,7	372	406	495	
MT PREMIUM		389	423	474		410	444	506	
OC LACKIERT		523	539	552		545	563	588	
		m³	0,09	0,09	0,09		0,09	0,09	0,09
		Kg	22,08	22,08	22,08		23,39	23,39	23,39

T. 48,6 H. 35 cm
2 Schubladen



	Art.-Nr.	Griff	Hohlkehle	Glas		Griff	Hohlkehle	Glas	
		3917005	391G7005	391V7005		3917009	391G7009	391V7009	
MT 1/ONE	B. 57,3	395	426	442	B. 90	198,00	473	604	
MT PREMIUM		432	463	485		217,50	512	621	
OC LACKIERT		571	591	646		289,50	668	733	
		m³	0,11	0,11	0,11		0,17	0,17	0,17
		Kg	26,56	26,56	26,56		37,34	37,34	37,34

T. 48,6 H. 35 cm
2 Schubladen

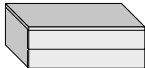

	Art.-Nr.	Griff	Hohlkehle	Glas		Griff	Hohlkehle	Glas	
		3917011	391G7011	391V7011		3917013	391G7013	391V7013	
MT 1/ONE	B. 98	465	498	643	B. 117,2	492	523	686	
MT PREMIUM		505	539	661		536	565	708	
OC LACKIERT		686	695	775		730	741	837	
		m³	0,19	0,19	0,19		0,22	0,22	0,22
		Kg	39,60	39,60	39,60		45,43	45,43	45,43

ANM.: Die Schubladenelemente werden mit Abschluss-Halterungen berechnet. Für Halterungen, Griffe und Hohlkehle die Ausführung Anthrazit oder Gris angeben.



Für die Front mit Griff und Hohlkehle ist anstelle der Schubladen ohne Aufpreis ein Schubkasten erhältlich – zur Art.-Nr. des Schubladenelements C1 hinzuzufügen



PRATICO

BODENSTEHENDE SCHUBLADENELEMENTE



MT 1/ONE
Rau

MT CNV
Canvas

MT NAM
Nussbaum
Bernstein

Metallausführungen

Anthrazit

Gris

MT PREMIUM
Rau









MT OC BG
Gipsweiß

MT OC MP
Perlmutter

MT OC ARN
Arena

MT OC BA
Basaltgrau

MT CC
Zement hell

MT CV
Zement Cava

MT CS
Zement dunkel









MT RNC
Astig hell

MT FO
Esche Oriente

MT RSB
Eiche Sand

MT RMK
Eiche Mokka

MT RT
Thermoeiche

MT RC
Eiche Kohlegrau

MT ALP
Alpaca

OC
Lackierungen



OC
Matt

Gläser



601
Gläser
Rauchglas

T. 48,6 H. 51 cm
3 Schubladen



	Art.-Nr.	Griff	Hohlkehle	Glas		Griff	Hohlkehle	Glas
		3917021	391G7021	391V7021		3917023	391G7023	391V7023
MT 1/ONE	B. 43,7	424	460	584	B. 47,7	442	492	626
MT PREMIUM		473	523	600		500	550	643
OC LACKIERT		657	680	700		683	710	747
		m³ 0,12	0,12	0,12		0,13	0,13	0,13
		Kg 29,05	29,05	29,05		30,64	30,64	30,64

T. 48,6 H. 51 cm
3 Schubladen



	Art.-Nr.	Griff	Hohlkehle	Glas		Griff	Hohlkehle	Glas
		3917025	391G7025	391V7025		3917029	391G7029	391V7029
MT 1/ONE	B. 57,3	474	521	715	B. 90	535	582	779
MT PREMIUM		531	578	731		599	639	803
OC LACKIERT		718	748	842		806	840	937
		m³ 0,16	0,16	0,16		0,25	0,25	0,25
		Kg 34,45	34,45	34,45		47,43	47,43	47,43

T. 48,6 H. 51 cm
3 Schubladen

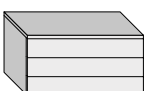

	Art.-Nr.	Griff	Hohlkehle	Glas		Griff	Hohlkehle	Glas
		3917031	391G7031	391V7031		3917033	391G7033	391V7033
MT 1/ONE	B. 98	562	612	830	B. 117,2	599	642	886
MT PREMIUM		620	670	854		658	701	915
OC LACKIERT		856	870	990		906	923	1.087
		m³ 0,27	0,27	0,27		0,32	0,32	0,32
		Kg 50,23	50,23	50,23		56,93	56,93	56,93

ANM.: Die Schubladenelemente werden mit Abschluss-Halterungen berechnet. Für Halterungen, Griffe und Hohlkehle die Ausführung Anthrazit oder Gris angeben.



Für die Front mit Griff und Hohlkehle ist anstelle der Schubladen ohne Aufpreis ein Schubkasten erhältlich – zur Art.-Nr. des Schubladenelements C1 hinzuzufügen



Typen- und Preisliste

PRATICO

BODENSTEHENDE SCHUBLADENELEMENTE

<p>MT 1/ONE Rau</p>  <p>MT CHV Canvas</p>  <p>MT NAM Nussbaum Bernstein</p>	<p>MT PREMIUM Rau</p>  <p>MT OC B6 Gipsweiß</p>  <p>MT OC MP Perlmutter</p>  <p>MT OC ARN Arena</p>  <p>MT OC BA Basaltgrau</p>  <p>MT CC Zement hell</p>  <p>MT CV Zement Cava</p>  <p>MT CS Zement dunkel</p>	<p>OC Lackierungen</p>  <p>OC Matt</p>
<p>Metallausführungen</p>  <p>Anthrazit</p>  <p>Gris</p>	 <p>MT RNC Astig hell</p>  <p>MT FO Esche Oriente</p>  <p>MT RSB Eiche Sand</p>  <p>MT RMK Eiche Mokka</p>  <p>MT RT Thermoeiche</p>  <p>MT RC Eiche Kohlegrau</p>  <p>MT ALP Alpaca</p>	<p>Gläser</p>  <p>601 Gläser Rauchglas</p>

T. 48,6 H. 67 cm
4 Schubladen

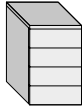

	Art.-Nr.	Griff	Hohlkehle	Glas		Griff	Hohlkehle	Glas
		3917041	391G7041	391V7041		3917043	391G7043	391V7043
MT 1/ONE	B. 43,7	495	544	709	B. 47,7	520	586	765
MT PREMIUM		580	647	749		615	682	807
OC LACKIERT		789	821	847		824	860	909
	m³	0,16	0,16	0,16		0,17	0,17	0,17
	Kg	36,02	36,02	36,02		37,88	37,88	37,88

T. 48,6 H. 67 cm
4 Schubladen

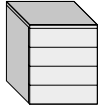

	Art.-Nr.	Griff	Hohlkehle	Glas		Griff	Hohlkehle	Glas
		3917045	391G7045	391V7045		3917049	391G7049	391V7049
MT 1/ONE	B. 57,3	556	619	878	B. 90	631	694	957
MT PREMIUM		651	714	919		733	786	1.005
OC LACKIERT		862	902	1.027		962	1.007	1.136
	m³	0,21	0,21	0,21		0,32	0,32	0,32
	Kg	42,34	42,34	42,34		57,53	57,53	57,53

T. 48,6 H. 67 cm
4 Schubladen

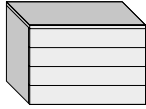

	Art.-Nr.	Griff	Hohlkehle	Glas		Griff	Hohlkehle	Glas
		3917051	391G7051	391V7051		3917053	391G7053	391V7053
MT 1/ONE	B. 98	663	730	1.020	B. 117,2	707	769	1.095
MT PREMIUM		757	824	1.069		805	863	1.148
OC LACKIERT		1.025	1.043	1.204		1.084	1.106	1.298
	m³	0,35	0,35	0,35		0,42	0,42	0,42
	Kg	60,87	60,87	60,87		68,43	68,43	68,43

ANM.: Die Schubladenelemente werden mit Abschluss-Halterungen berechnet.
Für Halterungen, Griffe und Hohlkehle die Ausführung Anthrazit oder Gris angeben.



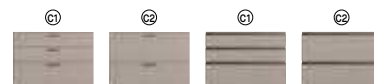

Für die Front mit Griff und Hohlkehle ist anstelle der Schubladen ohne Aufpreis ein Schubkasten erhältlich – zur Art.-Nr. des Schubladenelements C1 oder C2 hinzufügen.



PRATICO

BODENSTEHENDE SCHUBLADENELEMENTE



MT 1/ONE
Rau

MT CNV
Canvas

MT NAM
Nussbaum
Bernstein







Metallausführungen

Anthrazit

Gris

MT PREMIUM
Rau

MT OC BG
Gipsweiß

MT OC MP
Perlmutter







MT OC ARN
Arena

MT OC BA
Basaltgrau

MT CC
Zement hell

MT CV
Zement Cava

MT CS
Zement dunkel

MT RNC
Astig hell

MT FO
Esche Oriente

MT RSB
Eiche Sand

MT RMK
Eiche Mokka

MT RT
Thermoeiche

MT RC
Eiche Kohlegrau

MT ALP
Alpaca

OC
Lackierungen



OC
Matt

Gläser



601
Gläser
Rauchglas

T. 48,6 H. 83 cm
5 Schubladen

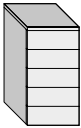

		Griff	Hohlkehle	Glas				Griff	Hohlkehle	Glas
Art.-Nr.		3917061	391G7061	391V7061	B. 47,7	3917063			391G7063	391V7063
MT 1/ONE	B. 43,7	555	617	872		702	667	891		
MT PREMIUM		660	744	992		960	786	942		
OC LACKIERT		920	823	584		668	1.005	1.066		
	m³	0,20	0,20	0,20	0,21	0,21	0,21			
	Kg	42,99	42,99	42,99	45,12	45,12	45,12			

T. 48,6 H. 83 cm
5 Schubladen



		Griff	Hohlkehle	Glas				Griff	Hohlkehle	Glas
Art.-Nr.		3917065	391G7065	391V7065	B. 90	3917069			391G7069	391V7069
MT 1/ONE	B. 57,3	628	706	1.029		721	799	1.128		
MT PREMIUM		745	823	1.079		845	912	1.185		
OC LACKIERT		1.004	1.054	1.210		1.122	1.177	1.339		
	m³	0,26	0,26	0,26	0,40	0,40	0,40			
	Kg	50,23	50,23	50,23	67,62	67,62	67,62			

T. 48,6 H. 83 cm
5 Schubladen

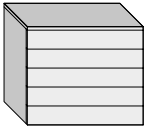

		Griff	Hohlkehle	Glas				Griff	Hohlkehle	Glas
Art.-Nr.		3917071	391G7071	391V7071	B. 117,2	3917073			391G7073	391V7073
MT 1/ONE	B. 98	755	838	1.201		808	884	1.291		
MT PREMIUM		869	952	1.259		924	997	1.354		
OC LACKIERT		1.192	1.214	1.415		1.258	1.286	1.525		
	m³	0,43	0,43	0,43	0,51	0,51	0,51			
	Kg	71,50	71,50	71,50	79,92	79,92	79,92			

ANM.: Die Schubladenelemente werden mit Abschluss-Halterungen berechnet. Für Halterungen, Griffe und Hohlkehle die Ausführung Anthrazit oder Gris angeben.



Für die Front mit Griff und Hohlkehle ist anstelle der Schubladen ohne Aufpreis ein Schubkasten erhältlich – zur Art.-Nr. des Schubladenelements C1 oder C2 hinzufügen.



Typen- und Preisliste

PRATICO

BODENSTEHENDE SCHUBLADENELEMENTE

<p>MT 1/ONE Rau</p>  <p>MT CHV Canvas</p>  <p>MT NAM Nussbaum Bernstein</p> <p>Metallausführungen</p>  <p>Anthrazit</p>  <p>Gris</p>	<p>MT PREMIUM Rau</p>  <p>MT OC B6 Gipsweiß</p>  <p>MT OC MP Perlmutter</p>  <p>MT OC ARN Arena</p>  <p>MT OC BA Basaltgrau</p>  <p>MT CC Zement hell</p>  <p>MT CV Zement Cava</p>  <p>MT CS Zement dunkel</p>  <p>MT RNC Astig hell</p>  <p>MT FO Esche Oriente</p>  <p>MT RSB Eiche Sand</p>  <p>MT RMK Eiche Mokka</p>  <p>MT RT Thermoeiche</p>  <p>MT RC Eiche Kohlegrau</p>  <p>MT ALP Alpaca</p>	<p>OC Lackierungen</p>  <p>OC Matt</p> <p>Gläser</p>  <p>601 Gläser Rauchglas</p>
--	---	---

T. 48,6 H. 99 cm
6 Schubladen

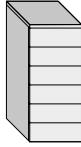

	Art.-Nr.	Griff	Hohlkehle	Glas		Griff	Hohlkehle	Glas
		3917081	391G7081	391V7081		3917083	391G7083	391V7083
MT 1/ONE	B. 43,7	626	699	947	B. 47,7	658	758	1.026
MT PREMIUM		744	844	998		792	892	1.079
OC LACKIERT		1.049	1.096	1.136		1.094	1.147	1.221
	m³	0,23	0,23	0,23		0,25	0,25	0,25
	Kg	49,96	49,96	49,96		52,36	52,36	52,36

T. 48,6 H. 99 cm
6 Schubladen

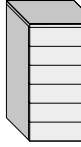

	Art.-Nr.	Griff	Hohlkehle	Glas		Griff	Hohlkehle	Glas
		3917085	391G7085	391V7085		3917089	391G7089	391V7089
MT 1/ONE	B. 57,3	708	802	1.190	B. 90	816	910	1.305
MT PREMIUM		841	934	1.242		956	1.036	1.364
OC LACKIERT		1.143	1.203	1.390		1.274	1.341	1.535
	m³	0,30	0,30	0,30		0,47	0,47	0,47
	Kg	52,87	52,87	52,87		70,57	70,57	70,57

T. 48,6 H. 99 cm
6 Schubladen

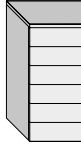

	Art.-Nr.	Griff	Hohlkehle	Glas		Griff	Hohlkehle	Glas
		3917091	391G7091	391V7091		3917093	391G7093	391V7093
MT 1/ONE	B. 98	859	959	1.394	B. 117,2	913	1.007	1.495
MT PREMIUM		986	1.086	1.454		1.045	1.132	1.560
OC LACKIERT		1.360	1.387	1.628		1.428	1.462	1.749
	m³	0,51	0,51	0,51		0,61	0,61	0,61
	Kg	82,14	82,14	82,14		91,42	91,42	91,42

ANM.: Die Schubladenelemente werden mit Abschluss-Halterungen berechnet.
Für Halterungen, Griffe und Hohlkehle die Ausführung Anthrazit oder Gris angeben.



Für die Front mit Griff und Hohlkehle ist anstelle der Schubladen ohne Aufpreis ein Schubkasten erhältlich – zur Art.-Nr. des Schubladenelements C1, C2 oder C3 hinzufügen.

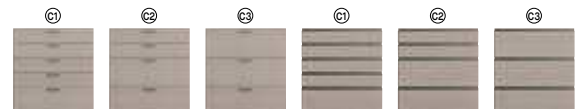

PRATICO

WANDHÄNGENDE SCHUBLADENELEMENTE

MT 1/ONE
Rau



MT CNV
Canvas



MT NAM
Nussbaum
Bernstein

Metallausführungen



Anthrazit



Gris

MT PREMIUM
Rau



MT OC BG
Gipsweiß



MT OC MP
Perlmutter



MT OC ARN
Arena



MT OC BA
Basaltgrau



MT CC
Zement hell



MT CV
Zement Cava



MT CS
Zement dunkel



MT RNC
Astig hell



MT FO
Esche Oriente



MT RSB
Eiche Sand



MT RMK
Eiche Mokka



MT RT
Thermoeiche



MT RC
Eiche Kohlegrau



MT ALP
Alpaca

OC
Lackierungen



OC
Matt

Gläser



601
Gläser
Rauchglas

T. 48,6 H. 19 cm
1 wandhängende Schublade



		Griff	Hohlkehle	Glas
Art.-Nr.		3917001S	391G7001S	391V7001S
MT 1/ONE	B. 43,7	293	306	347
MT PREMIUM		313	330	356
OC LACKIERT		379	387	394
		m ³ 0,05	0,05	0,05
		Kg 15,11	15,11	15,11

		Griff	Hohlkehle	Glas
Art.-Nr.		3917003S	391G7003S	391V7003S
MT 1/ONE	B. 47,7	303	320	365
MT PREMIUM		328	345	376
OC LACKIERT		396	405	417
		0,05	0,05	0,05
		16,15	16,15	16,15

T. 48,6 H. 19 cm
1 wandhängende Schublade

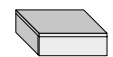

		Griff	Hohlkehle	Glas
Art.-Nr.		3917005S	391G7005S	391V7005S
MT 1/ONE	B. 57,3	320	336	400
MT PREMIUM		343	359	410
OC LACKIERT		417	427	458
		m ³ 0,06	0,06	0,06
		Kg 18,67	18,67	18,67

		Griff	Hohlkehle	Glas
Art.-Nr.		3917009S	391G7009S	391V7009S
MT 1/ONE	B. 90	350	366	432
MT PREMIUM		380	394	448
OC LACKIERT		476	487	520
		0,10	0,10	0,10
		27,24	27,24	27,24

T. 48,6 H. 19 cm
1 wandhängende Schublade



		Griff	Hohlkehle	Glas
Art.-Nr.		3917011S	391G7011S	391V7011S
MT 1/ONE	B. 98	370	387	459
MT PREMIUM		399	416	477
OC LACKIERT		506	511	551
		m ³ 0,11	0,11	0,11
		Kg 28,96	28,96	28,96

		Griff	Hohlkehle	Glas
Art.-Nr.		3917013S	391G7013S	391V7013S
MT 1/ONE	B. 117,2	388	404	485
MT PREMIUM		421	436	507
OC LACKIERT		543	549	597
		0,13	0,13	0,13
		33,93	33,93	33,93

ANM.: Die Schubladenelemente werden mit Abschluss-Halterungen berechnet.
Für Halterungen, Griffe und Hohlkehle die Ausführung Anthrazit oder Gris angeben.



Typen- und Preisliste

PRATICO

WANDHÄNGENDE SCHUBLADENELEMENTE

MT 1/ONE Rau   MT CHV Canvas MT NAM Nussbaum Bernstein	MT PREMIUM Rau        MT OC B6 Gipsweiß MT OC MP Perlmutter MT OC ARN Arena MT OC BA Basaltgrau MT CC Zement hell MT CV Zement Cava MT CS Zement dunkel	OC Lackierungen  OC Matt
Metallausführungen   Anthrazit Gris	       MT RNC Astig hell MT FO Esche Oriente MT RSB Eiche Sand MT RMK Eiche Mokka MT RT Thermoeiche MT RC Eiche Kohlegrau MT ALP Alpaca	Gläser  601 Gläser Rauchglas

T. 48,6 H. 35 cm
2 wandhängende Schubladen



	Art.-Nr.	Griff	Hohlkehle	Glas		Griff	Hohlkehle	Glas
		3917021S	391G7021S	391V7021S		3917023S	391G7023S	391V7023S
MT 1/ONE	B. 43,7	358	382	465	B. 47,7	372	406	495
MT PREMIUM		389	423	474		410	444	506
OC LACKIERT		523	539	552		545	563	588
		m³	0,09	0,09	0,09	0,09	0,09	0,09
		Kg	22,08	22,08	22,08	23,39	23,39	23,39

T. 48,6 H. 35 cm
2 wandhängende Schubladen



	Art.-Nr.	Griff	Hohlkehle	Glas		Griff	Hohlkehle	Glas
		3917025S	391G7025S	391V7025S		3917029S	391G7029S	391V7029S
MT 1/ONE	B. 57,3	395	426	555	B. 90	442	473	604
MT PREMIUM		432	463	565		485	512	621
OC LACKIERT		571	591	653		646	668	733
		m³	0,11	0,11	0,11	0,17	0,17	0,17
		Kg	26,56	26,56	26,56	37,34	37,34	37,34

T. 48,6 H. 35 cm
2 wandhängende Schubladen



	Art.-Nr.	Griff	Hohlkehle	Glas		Griff	Hohlkehle	Glas
		3917031S	391G7031S	391V7031S		3917033S	391G7033S	391V7033S
MT 1/ONE	B. 98	465	498	643	B. 117,2	492	523	708
MT PREMIUM		505	539	661		536	565	837
OC LACKIERT		686	695	775		730	741	495
		m³	0,19	0,19	0,19	0,22	0,22	0,22
		Kg	39,60	39,60	39,60	45,43	45,43	45,43

ANM.: Die Schubladenelemente werden mit Abschluss-Halterungen berechnet. Für Halterungen, Griffe und Hohlkehle die Ausführung Anthrazit oder Gris angeben.

Für die Front mit Griff und Hohlkehle ist anstelle der Schubladen ohne Aufpreis ein Schubkasten erhältlich – vor dem S der Art.-Nr. des Schubladenelements C1 einfügen.



PRATICO

HALTERUNGEN

Metallausführungen



Anthrazit



Gris

T. 29,4 cm Halterung für Fachboden



	Art.-Nr.	T. 29,4
Staffa Soporte	3919800	28
Staffa elettrificata SX Soporte elettrificato IZDA.	3919800SL	28
Staffa elettrificata DX Soporte elettrificato DCHA.	3919800DL	28
Staffa elettrificata CL Soporte elettrificato CENT.	3919800CL	28
	m ³	0,01
	Kg	0,21

T. 48,6 cm Halterung für Fachboden

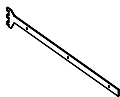

	Art.-Nr.	T. 48,6
Staffa Soporte	3919805	28
Staffa elettrificata SX Soporte elettrificato IZDA.	3919805SL	28
Staffa elettrificata DX Soporte elettrificato DCHA.	3919805DL	28
Staffa elettrificata CL Soporte elettrificato CENT.	3919805CL	28
	m ³	0,01
	Kg	0,34

T. 48,6 cm Halterung für schrägen Fachboden und Podest

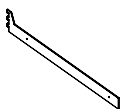

	Art.-Nr.	T. 48,6		Art.-Nr.	T. 48,6	
Halterung für schrägen Fachboden	3919805I	28		Halterung für Podest	3919806	32
	m ³	0,01		m ³	0,01	
	Kg	0,38		Kg	0,57	

ANM.: Für Halterungen die Ausführung Anthrazit oder Gris angeben.

Typen- und Preisliste

PRATICO

RASTER

**MT 1/ONE
Rau**

MT CHV
Canvas

MT NAM
Nussbaum
Bernstein

Metallausführungen

Anthrazit

Gris

**MT PREMIUM
Rau**

MT OC BG
Gipsweiß

MT OC MP
Perlmutter

MT OC ARN
Arena

MT OC BA
Basaltgrau

MT CC
Zement hell

MT CV
Zement Cava

MT CS
Zement dunkel

MT RNC
Astig hell

MT FO
Esche Oriente

MT RSB
Eiche Sand

MT RMK
Eiche Mokka

MT RT
Thermoeiche

MT RC
Eiche Kohlegrau

MT ALP
Alpaca

**OC
Lackierungen**

**OC
Matt**

**H. 48 cm
Element Raster als Aufsatz**

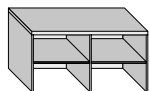

B. 90 - 98

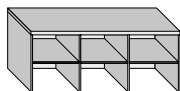

B. 117,2

		B. 90	B. 98	B. 117,2
	Art.-Nr.	3917809A	3917811A	3917813A
MT 1/ONE	T. 48,6	188	198	223
MT PREMIUM		254	268	310
OC LACKIERT		498	525	613
	m ³	0,24	0,26	0,31
	Kg	25,80	27,40	33,30

**H. 51 cm
Element Raster wandhängend**

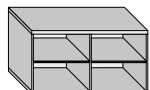

B. 90 - 98

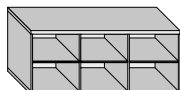

B. 117,2

		B. 90	B. 98	B. 117,2
	Art.-Nr.	3917809S	3917811S	3917813S
MT 1/ONE	T. 48,6	294	309	342
MT PREMIUM		378	396	454
OC LACKIERT		685	721	837
	m ³	0,26	0,29	0,34
	Kg	36,30	38,70	46,60

**B. 75÷110 cm
Kleiderlift mit Griff**

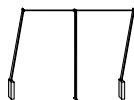

		B. 75÷110	
	Art.-Nr.	3329323	
ANTHRAZIT GRIS	T. 10,9	456	
	m ³	0,02	
	Kg	2,80	

ANM.: Die Elemente Raster werden mit Abschluss-Halterungen berechnet.
Für Halterungen die Ausführung Anthrazit oder Gris angeben.

PRATICO

STRUKTUR FÜR AUSZIEHBARE TABLETTS

<p>MT 1/ONE Rau</p>  <p>MT CNV Canvas</p>  <p>MT NAM Nussbaum Bernstein</p>	<p>MT PREMIUM Rau</p>  <p>MT OC BG Gipsweiß</p>  <p>MT OC MP Perlmutter</p>  <p>MT OC ARN Arena</p>  <p>MT OC BA Basaltgrau</p>  <p>MT CC Zement hell</p>  <p>MT CV Zement Cava</p>  <p>MT CS Zement dunkel</p>	<p>OC Lackierungen</p>  <p>OC Matt</p>
<p>Metallausführungen</p>  <p>Anthrazit</p>  <p>Gris</p>	 <p>MT RNC Astig hell</p>  <p>MT FO Esche Oriente</p>  <p>MT RSB Eiche Sand</p>  <p>MT RMK Eiche Mokka</p>  <p>MT RT Thermoeiche</p>  <p>MT RC Eiche Kohlegrau</p>  <p>MT ALP Alpaca</p>	

H. 11 cm
Struktur für 1 ausziehbares Tablett



		B. 43,7	B. 47,7	B. 57,3	B. 90	B. 98	B. 117,2
	Art.-Nr.	3917501	3917503	3917505	3917509	3917511	3917513
MT 1/ONE	T. 48,6	337	340	356	396	408	434
MT PREMIUM		356	360	378	433	444	476
OC LACKIERT		438	438	466	565	585	643
	m ³	0,03	0,03	0,04	0,06	0,07	0,08
	Kg	11,63	12,54	14,73	22,19	24,02	28,40

Immer ein ausziehbares Zubehörteil hinzufügen

H. 19 cm
Struktur für 2 ausziehbare Tablett



		B. 43,7	B. 47,7	B. 57,3	B. 90	B. 98	B. 117,2
	Art.-Nr.	3917521	3917523	3917525	3917529	3917531	3917533
MT 1/ONE	T. 48,6	563	571	593	662	681	725
MT PREMIUM		586	594	620	701	724	774
OC LACKIERT		661	676	714	843	870	948
	m ³	0,05	0,05	0,06	0,10	0,11	0,13
	Kg	15,79	17,02	19,97	30,03	32,50	38,41

Generell immer die Zusammenstellung der ausziehbaren Zubehörteile hinzufügen

ANM.: Die ausziehbaren Tablett werden mit Abschluss-Halterungen berechnet.
Für Halterungen die Ausführung Anthrazit oder Gris angeben.

Verwendung der ausziehbaren Zubehörteile

Struktur mit 1 Tablett:

- 1 Glasfachboden oder
- 1 Hosenhänger oder
- 1 Schuhablage;

Struktur mit 2 Tablett:

- 2 Glasfachböden oder
- 1 Glasfachboden + Hosenhänger oder
- 1 Glasfachboden + Schuhablage;

Typen- und Preisliste

PRATICO

ZUBEHÖRTEILE FÜR AUSZIEHBARE TABLETTS

Metallausführungen



Anthrazit



Gris

Gläser



601
Gläser
Rauchglas

ST. 0,4 cm

Glasfachboden für Struktur mit ausziehbarem Tablett



		B. 43,7	B. 47,7	B. 57,3	B. 90	B. 98	B. 117,2
Art.-Nr.		333V7701	333V7703	333V7705	333V7709	333V7711	333V7713
GLÄSER RAUCHGLAS	T. 38,9	32	37	42	62	67	78
m³		0,01	0,01	0,01	0,01	0,01	0,01
Kg		1,37	1,54	1,95	3,35	3,69	4,51

ST. 3,6 cm

Hosenhänger für Struktur mit ausziehbarem Tablett



		B. 43,7	B. 47,7	B. 57,3	B. 90	B. 98	B. 117,2
Art.-Nr.		333M7701P	333M7703P	333M7705P	333M7709P	333M7711P	333M7713P
ANTHRAZIT GRIS	T. 38,9	45	45	59	117	132	162
m³		0,01	0,01	0,01	0,01	0,01	0,02
Kg		0,98	1,11	1,4	2,41	2,66	3,25

ST. 24 cm

Schuhablage für Struktur mit ausziehbarem Tablett



		B. 43,7	B. 47,7	B. 57,3	B. 90	B. 98	B. 117,2
Art.-Nr.		333M7701S	333M7703S	333M7705S	333M7709S	333M7711S	333M7713S
ANTHRAZIT GRIS	T. 42,3	78	80	87	101	110	124
m³		0,03	0,04	0,05	0,08	0,09	0,10
Kg		7,12	8,02	10,16	17,47	19,25	23,54

ANM.: Für Hosenhänger und Schuhablage die Ausführung Anthrazit oder Gris angeben.

PRATICO

EINZELNE SCHUBLADEN

MT 1/ONE
Rau



MT CNV
Canvas



MT NAM
Nussbaum
Bernstein

Metallausführungen



Anthrazit



Gris

MT PREMIUM
Rau



MT OC BG
Gipsweiß



MT OC MP
Perlmutter



MT OC ARN
Arena



MT OC BA
Basaltgrau



MT CC
Zement hell



MT CV
Zement Cava



MT CS
Zement dunkel



MT RNC
Astig hell



MT FO
Esche Oriente



MT RSB
Eiche Sand



MT RMK
Eiche Mokka



MT RT
Thermoeiche



MT RC
Eiche Kohlegrau



MT ALP
Alpaca

OC
Lackierungen



OC
Matt

H. 15,7 cm
1 Schublade



		Griff	Hohlkehle	Glas				
Art.-Nr.		3338201	333G8201	333V8201	3338203	333G8203	333V8203	
MT 1/ONE	B. 43,7	54	66	107	B. 47,7	58	75	119
MT PREMIUM		65	81	107		71	88	119
OC LACKIERT		93	100	107		98	107	119
m³		0,04	0,04	0,04	0,04	0,04	0,04	
Kg		3,40	3,40	3,40	3,65	3,65	3,65	

H. 15,7 cm
1 Schublade



		Griff	Hohlkehle	Glas				
Art.-Nr.		3338205	333G8205	333V8205	3338209	333G8209	333V8209	
MT 1/ONE	B. 57,3	65	80	145	B. 90	78	94	159
MT PREMIUM		78	94	145		91	105	159
OC LACKIERT		104	114	145		116	127	159
m³		0,05	0,05	0,05	0,07	0,07	0,07	
Kg		4,23	4,23	4,23	6,21	6,21	6,21	

H. 15,7 cm
1 Schublade

57,00

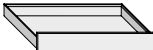

		Griff	Hohlkehle	Glas				
Art.-Nr.		3338211	333G8211	333V8211	3338213	333G8213	333V8213	
MT 1/ONE	B. 98	83	99	172	B. 117,2	89	105	186
MT PREMIUM		94	110	172		100	115	186
OC LACKIERT		127	132	172		133	138	186
m³		0,08	0,08	0,08	0,10	0,10	0,10	
Kg		6,69	6,69	6,69	7,40	7,40	7,40	

ANM.: Für Griff und Hohlkehle die Ausführung Anthrazit oder Gris angeben.



Typen- und Preisliste

PRATICO

EINZELNE SCHUBLADEN

**MT 1/ONE
Rau**



MT CHV
Canvas

MT NAM
Nussbaum
Bernstein

Metallausführungen



Anthrazit

Gris

**MT PREMIUM
Rau**



MT OC BG
Gipsweiß

MT OC MP
Perlmutter

MT OC ARN
Arena

MT OC BA
Basaltgrau

MT CC
Zement hell

MT CV
Zement Cava

MT CS
Zement dunkel

MT RNC
Astig hell

MT FO
Esche Oriente

MT RSB
Eiche Sand

MT RMK
Eiche Mokka

MT RT
Thermoeiche

MT RC
Eiche Kohlegrau

MT ALP
Alpaca

**OC
Lackierungen**



**OC
Matt**

H. 31,7 cm
1 Schubkasten



	Art.-Nr.	Griff		Hohlkehle		
		3338301	333G8301	3338303	333G8303	
MT 1/ONE	B. 43,7	107	132	B. 47,7	116	149
MT PREMIUM		129	163		143	176
OC LACKIERT		185	201		196	214
	m³	0,07	0,07		0,08	0,08
	Kg	4,44	4,44		4,78	4,78

H. 31,7 cm
1 Schubkasten

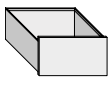

	Art.-Nr.	Griff		Hohlkehle		
		3338305	333G8305	3338309	333G8309	
MT 1/ONE	B. 57,3	129	161	B. 90	156	187
MT PREMIUM		156	187		183	94,00
OC LACKIERT		207	227		232	254
	m³	0,09	0,09		0,14	0,14
	Kg	5,59	5,59		8,35	8,35

H. 31,7 cm
1 Schubkasten

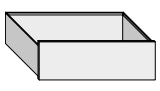

	Art.-Nr.	Griff		Hohlkehle		
		3338311	333G8311	3338313	333G8313	
MT 1/ONE	B. 98	165	198	B. 117,2	178	94,00
MT PREMIUM		187	221		201	230
OC LACKIERT		254	263		265	277
	m³	0,15	0,15		0,19	0,19
	Kg	9,03	9,03		9,74	9,74

ANM.: Für Griff und Hohlkehle die Ausführung Anthrazit oder Gris angeben.



PRATICO

ZUSCHNITTE NACH MASS

Bei diesen Elementen werden keine Kürzungen nach Maß durchgeführt:

- Schräge Fachböden
- Bodenstehende und wandhängende Schubladenelemente (Hohlkehle und Glas)
- Struktur für ausziehbare Tablett
- Element Raster mit ausziehbaren Tablett

ANM.: Kontaktieren Sie für nicht vorgesehene Strukturzuschnitte die technische Abteilung.

KÜRZUNGEN bei Wandverkleidungen

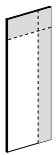

	€
Breitenzuschnitt (pro Zuschnitt)	+ 17
Höhenzuschnitt (pro Zuschnitt)	+ 17

KÜRZUNGEN bei Hängeschienen, Eck-Hängeschienen und seitlichen Profilen



	€
Zuschnitt der Hängeschiene	+ 33
Zuschnitt der Eck-Hängeschiene (pro Zuschnitt)	+ 17
Zuschnitt bei seitlichem Profil (pro Zuschnitt)	+ 17

BREITENKÜRZUNG bei Holzfachböden

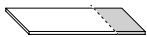

	€
Breitenzuschnitt (pro Zuschnitt)	+ 17

BREITENKÜRZUNG bei Podest aus Holz

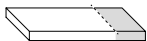

	€
Breitenzuschnitt (pro Zuschnitt)	+ 17

BEISPIEL AUSSCHNITT AUF DER WANDVERKLEIDUNG

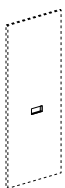

	€
Bearbeitung Ausschnitt auf der Wandverkleidung (pro Stück)	+ 65

PRATICO

ZUSCHNITTE NACH MASS UND GEMISCHTE KONFIGURATIONEN

BEISPIEL EINES DIAGONALEN ZUSCHNITTS

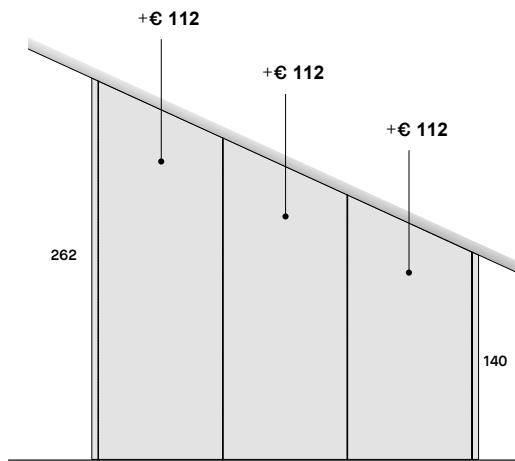

BEISPIEL EINES STUFENFÖRMIGEN ZUSCHNITTS

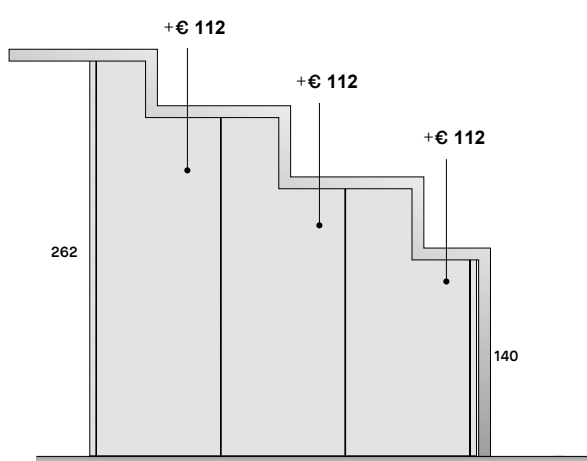

PRATICO

BEISPIELE FÜR GEMISCHTE KONFIGURATIONEN

Für eine mit gemischten Ausführungen und Fronten konfigurierte Innenausstattung empfiehlt sich der Einsatz des Grafikprogramms von Tomasella. Im Programm PRATICO können bei den Schubladenelementen unterschiedliche Fronten und Ausführungen konfiguriert werden.

Der Einsatz von Schubladen mit Glasfront in Kombination mit Schubladen mit Griff/Hohlkehle ist nicht möglich.

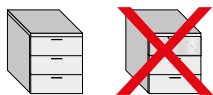

Beispiel einer Preisberechnung für Schubladenelement mit 3 Schubladen mit gemischten Ausführungen.

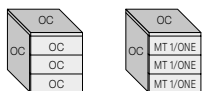

Schubladenelement 3 Schubladen mit Holzfront OC	-	3 einzelne Schubladen mit Holzfront OC	+	3 einzelne Schubladen mit Holzfront in MT 1/ONE
--	---	---	---	--

PRATICO

BELEUCHTUNG

Tabelle des Wattverbrauch je nach Breite des Fachbodens

	B. 43,7	B. 47,7	B. 57,3	B. 90	B. 98	B. 117,2
Wattverbrauch	2,45	2,74	3,46	5,76	6,34	7,77

Netzgeräte, Fernbedienung und Steuereinheit

	Art.-Nr.	230 V	110 V
Netzgerät 30 W	031L9620F	29	56
Netzgerät 50 W	031L9640F	50	60
Netzgerät 70 W	031L9660F	56	85
Netzgerät 100 W	031L9690F	85	107
Fernbedienung	-	32	
Steuereinheit	-	41	

Zur Verwendung mit direktem Netzanschluss.

Für die Verwendung mit Fernbedienung muss jedes vorhandene Netzgerät obligatorisch mit einer Steuereinheit kombiniert werden. Es ist möglich, mehrere Steuereinheiten über eine einzige Fernbedienung zu bedienen (wird komplett mit Wandhalterung geliefert). Bei Sondermaßen kann keine Beleuchtung eingesetzt werden.

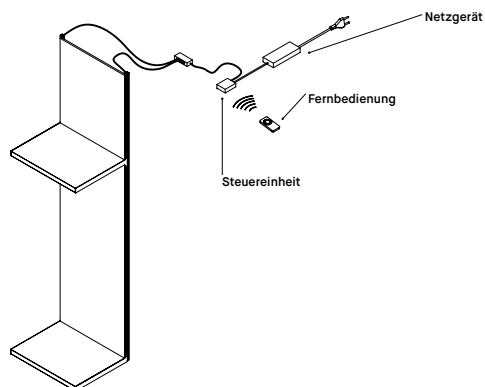

Beispiel für die Verwendung von Steuereinheiten / Netzgeräten für Beleuchtung, es ist auch möglich, 1 Fernbedienung für mehrere Netzgeräte zu verwenden.

Typen- und Preisliste



Ausgestattetes Inselmodul

AUSGESTATTETES
INSELMODUL

MODULÜBERSICHT



Beispiel f. danebenstehende Struktur

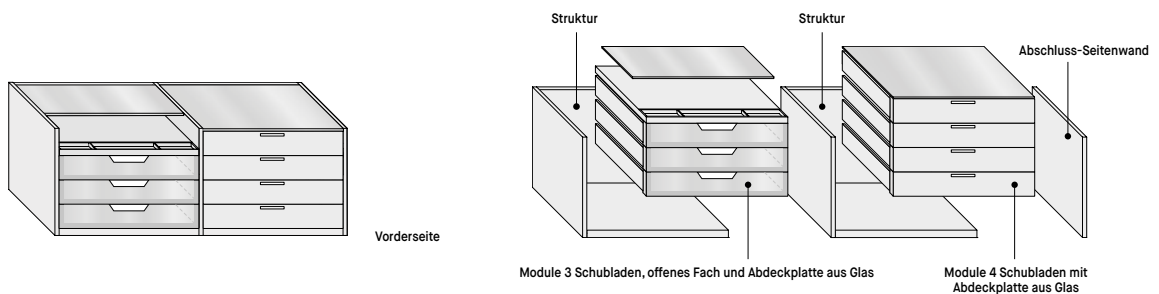

Beispiel f. danebenstehende/umgekehrte Struktur

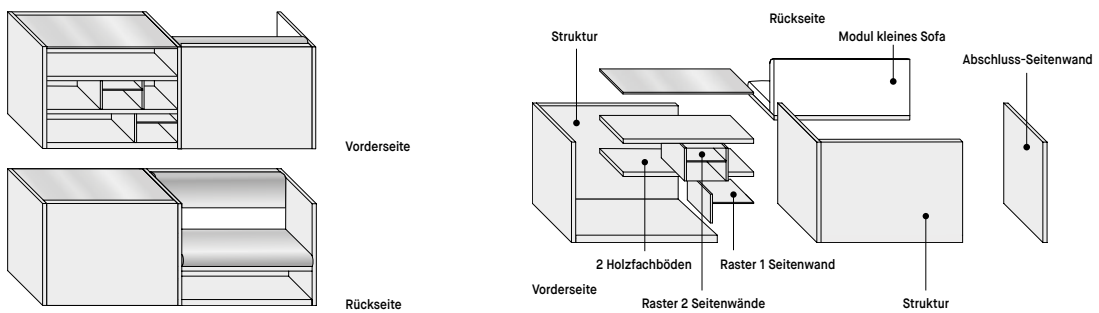

Typen- und Preisliste

AUSGESTATTETES INSELMODUL

MODULÜBERSICHT

Beispiel f. gegenüberliegende danebenstehende/umgekehrte Struktur

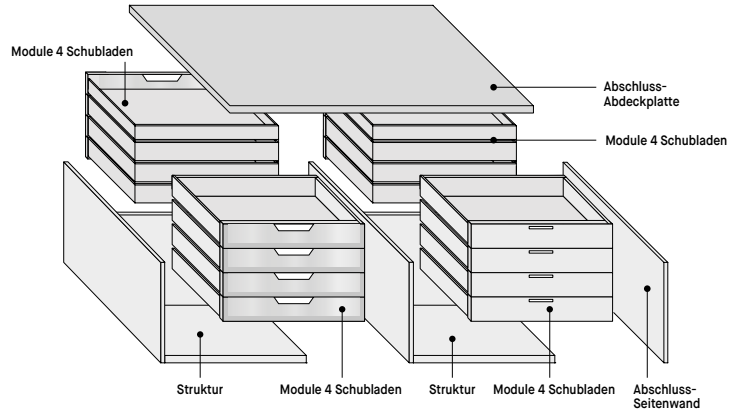
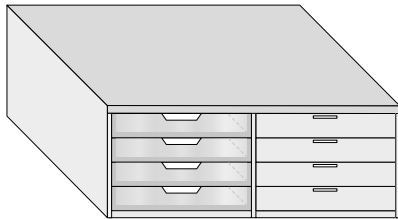

Raster für obere Schublade (als Extra)

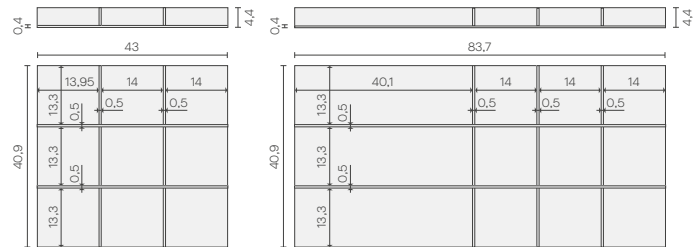

Schmuckfach

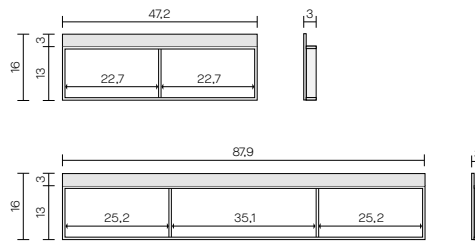



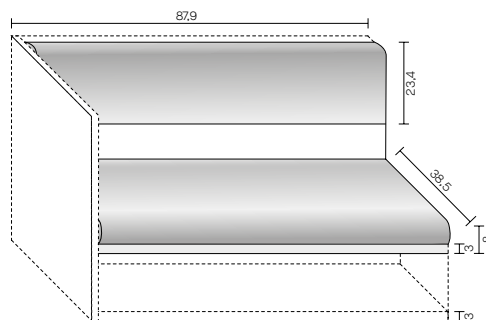













Modul kleines Sofa



AUSGESTATTETES INSELMODUL

STRUKTUR FÜR MODUL MIT ABDECKPLATTE AUS GLAS

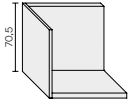
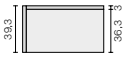

<p>MT 1/ONE Rau</p> <div style="display: flex; justify-content: space-around;"> <div style="text-align: center;">  MT CNV Canvas </div> <div style="text-align: center;">  MT NAM Nussbaum Bernstein </div> </div>	<p>MT PREMIUM Rau</p> <div style="display: grid; grid-template-columns: repeat(7, 1fr); gap: 5px;"> <div style="text-align: center;"> MT OC BG Gipsweiß</div> <div style="text-align: center;"> MT OC MP Perlmutter</div> <div style="text-align: center;"> MT OC ARN Arena</div> <div style="text-align: center;"> MT OC BA Basaltgrau</div> <div style="text-align: center;"> MT CC Zement hell</div> <div style="text-align: center;"> MT CV Zement Cava</div> <div style="text-align: center;"> MT CS Zement dunkel</div> <div style="text-align: center;"> MT RNC Astig hell</div> <div style="text-align: center;"> MT FO Esche Oriente</div> <div style="text-align: center;"> MT RSB Eiche Sand</div> <div style="text-align: center;"> MT RMK Eiche Mokka</div> <div style="text-align: center;"> MT RT Thermoeiche</div> <div style="text-align: center;"> MT RC Eiche Kohlegrau</div> <div style="text-align: center;"> MT ALP Alpaca</div> </div>	<p>OC Lackiert</p> <div style="text-align: center;">  OC Matt </div>
---	--	--

H. 70,5 cm T. 39,3 cm
Struktur für Modul Isola

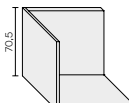

	Art.-Nr.	391V3012	391V3014
MT 1/ONE		130	169
MT PREMIUM	B. 50,2	155	B. 90,9 210
OC LACKIERT		264	372
	m ³	17,52	27,27
	Kg	0,04	0,06

H. 70,5 cm T. 49,7 cm
Struktur für Modul Isola

	Art.-Nr.	391V3022	391V3024
MT 1/ONE		143	173
MT PREMIUM	B. 50,2	172	B. 90,9 216
OC LACKIERT		287	399
	m ³	20,54	31,47
	Kg	0,05	0,07

H. 70,5 cm T. 75,6 cm
Gegenüberliegende Struktur für Modul Isola

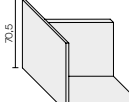



















	Art.-Nr.	391V3032	391V3034
MT 1/ONE		201	262
MT PREMIUM	B. 50,2	235	B. 90,9 312
OC LACKIERT		395	534
	m ³	27,09	40,15
	Kg	0,06	0,10

Typen- und Preisliste

AUSGESTATTETES INSELMODUL

STRUKTUR FÜR MODUL MIT ABDECKPLATTE AUS GLAS

<p>MT 1/ONE Rau</p> <div style="display: flex; justify-content: space-around;"> <div style="text-align: center;">  MT CHV Canvas </div> <div style="text-align: center;">  MT NAM Nussbaum Bernstein </div> </div>	<p>MT PREMIUM Rau</p> <div style="display: grid; grid-template-columns: repeat(7, 1fr); gap: 5px;"> <div style="text-align: center;"> MT OC BG Gipsweiß</div> <div style="text-align: center;"> MT OC MP Perlmutter</div> <div style="text-align: center;"> MT OC ARN Arena</div> <div style="text-align: center;"> MT OC BA Basaltgrau</div> <div style="text-align: center;"> MT CC Zement hell</div> <div style="text-align: center;"> MT CV Zement Cava</div> <div style="text-align: center;"> MT CS Zement dunkel</div> </div> <div style="display: grid; grid-template-columns: repeat(7, 1fr); gap: 5px; margin-top: 10px;"> <div style="text-align: center;"> MT RNC Astig hell</div> <div style="text-align: center;"> MT FO Esche Oriente</div> <div style="text-align: center;"> MT RSB Eiche Sand</div> <div style="text-align: center;"> MT RMK Eiche Mokka</div> <div style="text-align: center;"> MT RT Thermoeiche</div> <div style="text-align: center;"> MT RC Eiche Kohlegrau</div> <div style="text-align: center;"> MT ALP Alpaca</div> </div>	<p>OC Lackiert</p> <div style="text-align: center;">  OC Matt </div>
---	---	--

H. 70,5 cm T. 86 cm
Gegenüberliegende Struktur für Modul Isola

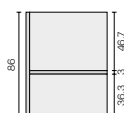
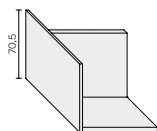

	Art.-Nr.	391V3042	391V3044
MT 1/ONE		211	263
MT PREMIUM	B. 50,2	249	B. 90,9 316
OC LACKIERT		417	561
	m ³	30,12	44,36
	Kg	0,07	0,10

H. 70,5 cm T. 96,4 cm
Gegenüberliegende Struktur für Modul Isola

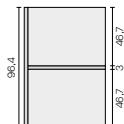
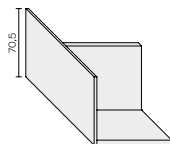

	Art.-Nr.	391V3052	391V3054
MT 1/ONE		249	265
MT PREMIUM	B. 50,2	285	B. 90,9 318
OC LACKIERT		510	586
	m ³	33,14	48,56
	Kg	0,08	0,11

H. 70,5 cm ST. 3 cm
Abschluss-Seitenwand für Zusammenstellung



	Art.-Nr.	T. 39,3	T. 49,7	T. 75,6	T. 86	T. 96,4
MT 1/ONE		37	43	54	58	64
MT PREMIUM	H. 70,5	48	59	76	84	90
OC LACKIERT		95	115	163	183	202
	m ³	6,22	7,86	11,96	13,61	15,25
	Kg	0,02	0,02	0,03	0,03	0,04

AUSGESTATTETES INSELMODUL

STRUKTUR MIT ABSCHLUSS-ABDECKPLATTE AUS HOLZ

<p>MT 1/ONE Rau</p> <div style="display: flex; justify-content: space-around;"> <div style="text-align: center;">  <p>MT CNV Canvas</p> </div> <div style="text-align: center;">  <p>MT NAM Nussbaum Bernstein</p> </div> </div>	<p>MT PREMIUM Rau</p> <div style="display: grid; grid-template-columns: repeat(7, 1fr); gap: 5px;"> <div style="text-align: center;"><p>MT OC BG Gipsweiß</p></div> <div style="text-align: center;"><p>MT OC MP Perlmutter</p></div> <div style="text-align: center;"><p>MT OC ARN Arena</p></div> <div style="text-align: center;"><p>MT OC BA Basaltgrau</p></div> <div style="text-align: center;"><p>MT CC Zement hell</p></div> <div style="text-align: center;"><p>MT CV Zement Cava</p></div> <div style="text-align: center;"><p>MT CS Zement dunkel</p></div> <div style="text-align: center;"><p>MT RNC Astig hell</p></div> <div style="text-align: center;"><p>MT FO Esche Oriente</p></div> <div style="text-align: center;"><p>MT RSB Eiche Sand</p></div> <div style="text-align: center;"><p>MT RMK Eiche Mokka</p></div> <div style="text-align: center;"><p>MT RT Thermoeiche</p></div> <div style="text-align: center;"><p>MT RC Eiche Kohlegrau</p></div> <div style="text-align: center;"><p>MT ALP Alpaca</p></div> </div>	<p>OC Lackiert</p> <div style="text-align: center;">  <p>OC Matt</p> </div>
---	--	--

H. 69,4 cm T. 39,3 cm
Struktur für Modul Isola

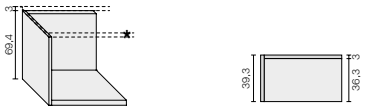

	Art.-Nr.	3913012	3913014	Abdeckplatte aus Holz 3916011
MT 1/ONE		130	169	42
MT PREMIUM	B. 50,2	155	B. 90,9 372	ST. 3 52
OC LACKIERT		264	372	67
	m³	17,30	26,95	11,97
	Kg	0,04	0,06	0,03

* Abschluss-Abdeckplatte pro Lfm. T. 39,3

H. 69,4 cm T. 49,7 cm
Struktur für Modul Isola

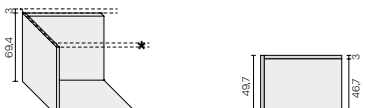

	Art.-Nr.	3913022	3913024	Abdeckplatte aus Holz 3916013
MT 1/ONE		143	173	54
MT PREMIUM	B. 50,2	172	B. 90,9 216	ST. 3 67
OC LACKIERT		287	399	98
	m³	20,30	31,13	15,13
	Kg	0,05	0,07	0,04

* Abschluss-Abdeckplatte pro Lfm. T. 49,7

H. 69,4 cm T. 75,6 cm
Gegenüberliegende Struktur für Modul Isola



















	Art.-Nr.	3913032	3913034	Abdeckplatte aus Holz 3916015
MT 1/ONE		201	262	56
MT PREMIUM	B. 50,2	235	B. 90,9 312	ST. 3 72
OC LACKIERT		395	534	116
	m³	26,78	39,74	22,98
	Kg	0,06	0,09	0,05

* Abschluss-Abdeckplatte pro Lfm. T. 75,6

Typen- und Preisliste

AUSGESTATTETES INSELMODUL

STRUKTUR MIT ABSCHLUSS-ABDECKPLATTE AUS HOLZ

MT 1/ONE Rau  MT CHV Canvas  MT NAM Nussbaum Bernstein	MT PREMIUM Rau  MT OC B6 Gipsweiß  MT OC MP Perlmutter  MT OC ARN Arena  MT OC BA Basaltgrau  MT CC Zement hell  MT CV Zement Cava  MT CS Zement dunkel  MT RNC Astig hell  MT FO Esche Oriente  MT RSB Eiche Sand  MT RMK Eiche Mokka  MT RT Thermoeiche  MT RC Eiche Kohlegrau  MT ALP Alpaca	OC Lackiert  OC Matt
--	--	---

H. 69,4 cm T. 86 cm
Gegenüberliegende Struktur für Modul Isola

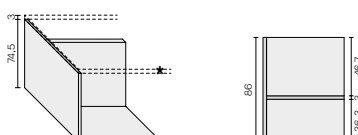

	Art.-Nr.	3913042	3913044	Abdeckplatte aus Holz 3916017
MT 1/ONE		211	263	66
MT PREMIUM	B. 50,2	249	B. 90,9 316	ST. 3 89
OC LACKIERT		417	561	136
	m ³	29,78	43,92	26,13
	Kg	0,07	0,10	0,06

* Abschluss-Abdeckplatte pro Lfm. T. 86

H. 69,4 cm T. 96,4 cm
Gegenüberliegende Struktur für Modul Isola

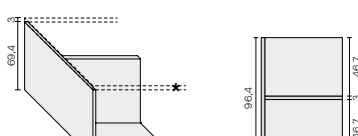

	Art.-Nr.	3913052	3913054	Abdeckplatte aus Holz 3916019
MT 1/ONE		249	265	78
MT PREMIUM	B. 50,2	285	B. 90,9 318	ST. 3 107
OC LACKIERT		510	586	165
	m ³	32,78	48,10	29,29
	Kg	0,08	0,11	0,07

* Abschluss-Abdeckplatte pro Lfm. T. 96,4



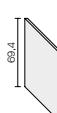

















H. 69,4 cm ST. 3 cm
Abschluss-Seitenwand für Zusammenstellung



	Art.-Nr.	T. 39,3	T. 49,7	T. 75,6	T. 86	T. 96,4
MT 1/ONE		37	43	54	58	64
MT PREMIUM	H. 69,4	48	59	76	84	90
OC LACKIERT		95	115	163	183	202
	m ³	6,12	7,74	11,77	13,39	15,01
	Kg	0,01	0,02	0,03	0,03	0,04

AUSGESTATTETES INSELMODUL

MODULE FÜR STRUKTUREN MIT ABDECKPLATTE AUS GLAS

MT 1/ONE Rau  MT CNV Canvas  MT NAM Nussbaum Bernstein	MT PREMIUM Rau  MT OC BG Gipsweiß  MT OC MP Perlmutter  MT OC ARN Arena  MT OC BA Basaltgrau  MT CC Zement hell  MT CV Zement Cava  MT CS Zement dunkel	OC Lackiert  OC Matt Gläser  601 Gläser Rauchglas
Metallausführungen  Anthrazit  Gris	 MT RNC Astig hell  MT FO Esche Oriente  MT RSB Eiche Sand  MT RMK Eiche Mokka  MT RT Thermoeiche  MT RC Eiche Kohlegrau  MT ALP Alpaca	

T. 49,7 H. 64,4 cm
4 Schubladen mit Abdeckplatte aus Glas

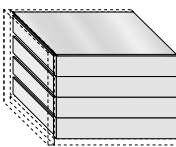

		Griff	Hohlkehle	Glas				
Art.-Nr.		3917222A	391G7222A	391V7222A	Griff	Hohlkehle	Glas	
		3917224A	391G7224A	391V7224A				
MT 1/ONE	B. 47,2	524	249,00	934	B. 87,9	634	719	1.063
MT PREMIUM		537	569	939		648	737	1.072
OC LACKIERT		582	613	943		733	817	1.085
m ³		23,10	23,10	23,10	38,07	38,07	38,07	
Kg		0,16	0,16	0,16	0,30	0,30	0,30	

T. 49,7 H. 64,4 cm
3 Schubladen, offenes Fach und Abdeckplatte aus Glas

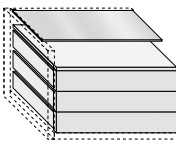

		Griff	Hohlkehle	Glas				
Art.-Nr.		3917222B	391G7222B	391V7222B	Griff	Hohlkehle	Glas	
		3917224B	391G7224B	391V7224B				
MT 1/ONE	B. 47,2	434	205,00	741	B. 87,9	518	582	840
MT PREMIUM		457	481	758		546	613	864
OC LACKIERT		507	532	778		676	739	940
m ³		22,38	22,38	22,38	37,97	37,97	37,97	
Kg		0,13	0,13	0,13	0,24	0,24	0,24	

T. 49,7 H. 64,4 cm
3 Schubladen, offenes Fach, Schmucktablett und Abdeckplatte aus Glas

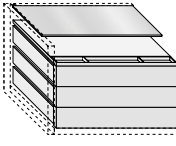

		Griff	Hohlkehle	Glas				
Art.-Nr.		3917222E	391G7222E	391V7222E	Griff	Hohlkehle	Glas	
		3917224E	391G7224E	391V7224E				
MT 1/ONE	B. 47,2	627	650	934	B. 87,9	711	775	1.032
MT PREMIUM		650	673	951		739	806	1.057
OC LACKIERT		700	724	971		869	932	1.133
m ³		22,65	22,65	22,65	38,48	38,48	38,48	
Kg		0,13	0,13	0,13	0,24	0,24	0,20	

ANM.: Für Griffe und Hohlkehle die Ausführung Anthrazit oder Gris angeben.

Raster für obere Schublade als Extra.
Für Abmessungen Rasterelement siehe Seite 71



















B. 47,2	280
B. 87,9	309



Typen- und Preisliste

AUSGESTATTETES INSELMODUL

OFFENES MODUL UND KLEINES SOFA

MT 1/ONE Rau  MT CNV Canvas  MT NAM Nussbaum Bernstein	MT PREMIUM Rau  MT OC BG Gipsweiß  MT OC MP Perlmutter  MT OC ARN Arena  MT OC BA Basaltgrau  MT CC Zement hell  MT CV Zement Cava  MT CS Zement dunkel  MT RNC Astig hell  MT FO Esche Oriente  MT RSB Eiche Sand  MT RMK Eiche Mokka  MT RT Thermoeiche  MT RC Eiche Kohlegrau  MT ALP Alpaca	OC Lackiert  OC Matt Gläser  601 Gläser Rauchglas
---	---	---

T. 39,3 H. 64,4 cm
2 Holzfachböden und 1 Glasfachboden

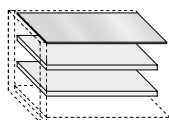

	Art.-Nr.	3917212G	3917214G
MT 1/ONE		144	166
MT PREMIUM	B. 47,2	159	184
OC LACKIERT		206	311
	m ³	11,36	21,19
	Kg	0,02	0,04

T. 49,7 H. 64,4 cm
2 Holzfachböden und 1 Glasfachboden

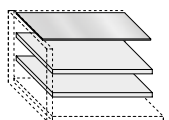

	Art.-Nr.	3917222G	3917224G
MT 1/ONE		162	186
MT PREMIUM	B. 47,2	188	222
OC LACKIERT		222	353
	m ³	13,58	25,29
	Kg	0,03	0,05

T. 38,5 H. 64,4 cm
Modul kleines Sofa

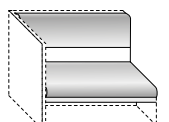

Struktur	Art.-Nr.	1/One	A	B	C	E	F	
MT 1/ONE		436	203,00	501	540	727	816	
MT PREMIUM	B. 87,9	3917214P	445	462	510	549	736	825
OC LACKIERT			508	525	573	612	799	889
	m ³				23,15			
	Kg				0,07			

Ausführungen für Bezug























Stoffe der Musterkarte

- 1/ONE** Easy / Selfie / Surround / Kundenstoff
- A** Smile / Boston / Alkemia
- B** Daytona / Texas / Lederimitat
- C** Linara / Allure unito / Allure coordinato / Favola / Sancho / Lino Froissé
- E** Pelle Fiore
- F** Pelle Vintage

AUSGESTATTETES INSELMODUL

MODULE FÜR STRUKTUR MIT ABSCHLUSS-ABDECKPLATTE AUS HOLZ

MT 1/ONE Rau  MT CNV Canvas  MT NAM Nussbaum Bernstein	MT PREMIUM Rau  MT OC BG Gipsweiß  MT OC MP Perlmutter  MT OC ARN Arena  MT OC BA Basaltgrau  MT CC Zement hell  MT CV Zement Cava  MT CS Zement dunkel	OC Lackiert  OC Matt Gläser  601 Gläser Rauchglas
Metallausführungen  Anthrazit  Gris	 MT RNC Astig hell  MT FO Esche Oriente  MT RSB Eiche Sand  MT RMK Eiche Mokka  MT RT Thermoeiche  MT RC Eiche Kohlegrau  MT ALP Alpaca	

T. 49,7 H. 64,4 cm
4 Schubladen

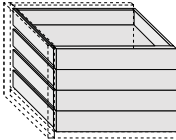

		Griff	Hohlkehle	Glas				
		Art.-Nr.	3917222A	391G7222A	391V7222A	Griff	Hohlkehle	Glas
			3917224A	391G7224A	391V7224A			
MT 1/ONE	B. 47,2	419	450	830	B. 87,9	504	589	930
MT PREMIUM		433	464	834		517	607	941
OC LACKIERT		477	508	838		602	687	954
		m ³	18,32	18,32	18,32	29,16	29,16	29,16
		Kg	0,16	0,16	0,16	0,30	0,30	0,30

T. 49,7 H. 64,4 cm
3 Schubladen, offenes Fach

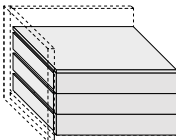

		Griff	Hohlkehle	Glas				
		Art.-Nr.	3917222B	391G7222B	391V7222B	Griff	Hohlkehle	Glas
			3917224B	391G7224B	391V7224B			
MT 1/ONE	B. 47,2	357	380	298,00	B. 87,9	424	487	745
MT PREMIUM		380	404	681		452	518	769
OC LACKIERT		430	454	701		581	644	845
		m ³	18,68	18,68	18,68	31,06	31,06	31,06
		Kg	0,13	0,13	0,13	0,24	0,24	0,24

ANM.: Für Griffe und Hohlkehle die Ausführung Anthrazit oder Gris angeben.

Raster für obere Schublade als Extra. Für Abmessungen Rasterelement siehe Seite 71	B. 47,2	125,50
	B. 87,9	138,50



















Das Modul kann ausschließlich mit Holzabdeckplatte eingesetzt werden

Typen- und Preisliste

AUSGESTATTETES INSELMODUL

MODULE FÜR STRUKTUR MIT ABSCHLUSS-ABDECKPLATTE AUS HOLZ

<p>MT 1/ONE Rau</p> <div style="display: flex; justify-content: space-around;"> <div style="text-align: center;">  MT CNV Canvas </div> <div style="text-align: center;">  MT NAM Nussbaum Bernstein </div> </div>	<p>MT PREMIUM Rau</p> <div style="display: grid; grid-template-columns: repeat(3, 1fr); gap: 10px;"> <div style="text-align: center;">  MT OC BG Gipsweiß </div> <div style="text-align: center;">  MT OC MP Perlmutter </div> <div style="text-align: center;">  MT OC ARN Arena </div> <div style="text-align: center;">  MT OC BA Basaltgrau </div> <div style="text-align: center;">  MT CC Zement hell </div> <div style="text-align: center;">  MT CV Zement Cava </div> <div style="text-align: center;">  MT CS Zement dunkel </div> <div style="text-align: center;">  MT RNC Astig hell </div> <div style="text-align: center;">  MT FO Esche Oriente </div> <div style="text-align: center;">  MT RSB Eiche Sand </div> <div style="text-align: center;">  MT RMK Eiche Mokka </div> <div style="text-align: center;">  MT RT Thermoeiche </div> <div style="text-align: center;">  MT RC Eiche Kohlegrau </div> <div style="text-align: center;">  MT ALP Alpaca </div> </div>	<p>OC Lackiert</p> <div style="text-align: center;">  OC Matt </div>
---	---	--

T. 39,3 H. 64,4 cm
2 Holzfachböden

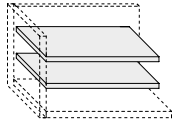

	Art.-Nr.	3917212G	3917214G
MT 1/ONE		83	71
MT PREMIUM	B. 47,2	83	B. 87,9 89
OC LACKIERT		129	216
	m ³	7,66	14,28
	Kg	0,02	0,03

T. 49,7 H. 64,4 cm
2 Holzfachböden

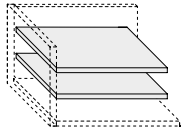

	Art.-Nr.	3917222G	3917224G
MT 1/ONE		85	91
MT PREMIUM	B. 47,2	112	B. 87,9 127
OC LACKIERT		145	259
	m ³	9,88	18,38
	Kg	0,02	0,04

AUSGESTATTETES INSELMODUL

SCHUBLADEN UND HOLZEINLEGEBODEN

MT 1/ONE
Rau



MT CNV
Canvas



MT NAM
Nussbaum
Bernstein

Metallausführungen



Anthrazit



Gris

MT PREMIUM
Rau



MT OC BG
Gipsweiß



MT OC MP
Perlmutter



MT OC ARN
Arena



MT OC BA
Basaltgrau



MT CC
Zement hell



MT CV
Zement Cava



MT CS
Zement dunkel



MT RNC
Astig hell



MT FO
Esche Oriente



MT RSB
Eiche Sand



MT RMK
Eiche Mokka



MT RT
Thermoeiche



MT RC
Eiche Kohlegrau



MT ALP
Alpaca

OC Lackiert



OC
Matt

Gläser



601
Gläser
Rauchglas

H. 15,7 T. 49,7 cm (module) Schublade



	Art.-Nr.	Griff	Hohlkehle	Glas		Griff	Hohlkehle	Glas
		3918222	391G8222	391V8222		3918224	391G8224	391V8224
MT 1/ONE	B. 47,2	105	113	207	B. 87,9	126	147	233
MT PREMIUM		108	116	209		129	152	235
OC LACKIERT		119	127	209		151	172	239
		m ³ 4,58	4,58/	4,58		7,29	7,29	7,29
		Kg 0,04	0,04	0,04		0,07	0,07	0,07

ST. 3 cm Holzeinlegeboden



	Für Modul	T. 39,3		T. 49,7		
		Art.-Nr.	3916412	3916422	3916414	3916424
MT 1/ONE	B. 47,2	33	42	B. 87,9	36	46
MT PREMIUM		41	56		45	64
OC LACKIERT		65	72		108	129
		m ³ 3,83	4,94		7,14	9,19
		Kg 0,01	0,01		0,02	0,02





















ANM.: Für Griff und Hohlkehle die Ausführung Anthrazit oder Gris angeben.



Typen- und Preisliste

AUSGESTATTETES INSELMODUL

ABDECKPLATTE AUS GLAS UND RASTER

MT 1/ONE Rau  MT CNV Canvas  MT NAM Nussbaum Bernstein	MT PREMIUM Rau  MT OC BG Gipsweiß  MT OC MP Perlmutter  MT OC ARN Arena  MT OC BA Basaltgrau  MT CC Zement hell  MT CV Zement Cava  MT CS Zement dunkel	OC Lackiert  OC Matt
Metallausführungen  Anthrazit  Gris	 MT RNC Astig hell  MT FO Esche Oriente  MT RSB Eiche Sand  MT RMK Eiche Mokka  MT RT Thermoeiche  MT RC Eiche Kohlegrau  MT ALP Alpaca	Gläser  601 Gläser Rauchglas

ST. 0,8 cm
Abdeckplatte Rauchglas



		T. 39,3	T. 49,7	T. 39,3	T. 49,7
	Art.-Nr.	391V6012	391V6022	391V6014	391V6024
GLÄSER RAUCHGLAS	B. 47,2	77	95	B. 87,9	105
	m ³	3,70	4,78	6,91	8,91
	Kg	0,01	0,01	0,01	0,01

H. 22,5 cm
Raster 1 Seitenwand

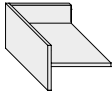

		T. 35,8	T. 46,2
	Art.-Nr.	3917811	3917821
MT 1/ONE		57	57
MT PREMIUM	B. 27,4	70	B. 27,4
OC LACKIERT		120	120
	m ³	3,15	3,66
	Kg	0,03	0,03

H. 22,5 cm
Raster 2 Seitenwände

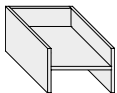

		T. 35,8	T. 46,2
	Art.-Nr.	3917812	3917822
MT 1/ONE		76	76
MT PREMIUM	B. 28,8	94	B. 28,8
OC LACKIERT		161	161
	m ³	3,97	4,71
	Kg	0,03	0,04

Contur

Typen- und Preisliste

AUSFÜHRUNGEN PRATICO

WANDPANEEL

MATERIAL: Holzagglomeratplatten mit niedriger Formaldehydabgabe (CARB);
STÄRKE: 14 mm;
AUSFÜHRUNG: Rau, Rau mit Grafikmuster oder Rau lackiert;

ABSCHLUSSPROFILE

MATERIAL: Holzagglomeratplatten mit niedriger Formaldehydabgabe (CARB);
STÄRKE: 14 mm;
AUSFÜHRUNG: Rau oder Rau lackiert;

HÄNGESCHIENEN

MATERIAL: eloxiertes Aluminium;

PODESTE

MATERIAL: Holzagglomeratplatten mit niedriger Formaldehydabgabe (CARB);
STÄRKE: 50 mm;
AUSFÜHRUNG: Rau oder Rau lackiert;

FIXER SPIEGEL

MATERIAL: Holzagglomeratplatten mit niedriger Formaldehydabgabe (CARB);
STÄRKE: 14 mm;
AUSFÜHRUNG: Rau oder Rau lackiert;

AUSFÜHRUNGEN DOXA

SEITENWAND und TRENNWAND

MATERIAL: Holzagglomeratplatten mit niedriger Formaldehydabgabe (CARB);
STÄRKE: 30 mm;
AUSFÜHRUNG: Rau oder Rau lackiert;

RÜCKWÄNDE

MATERIAL: Holzagglomeratplatten mit niedriger Formaldehydabgabe (CARB);
STÄRKE: 8 mm;
AUSFÜHRUNG: Rau oder Rau lackiert;

FACHBODEN UND ABDECKUNG

MATERIAL: Holzagglomeratplatten mit niedriger Formaldehydabgabe (CARB);
STÄRKE: Fachboden 30 mm;
AUSFÜHRUNG: Rau oder Rau lackiert;
TRAGFÄHIGKEIT: Tragfähigkeit max. 40 kg;

PODESTE

MATERIAL: Holzagglomeratplatten mit niedriger Formaldehydabgabe (CARB);
STÄRKE: 50 mm;
AUSFÜHRUNG: Rau oder Rau lackiert;

AUSFÜHRUNGEN LIBERTY

RAHMEN

MATERIAL: Ausführung Aluminium Anthrazit oder Gris;
STÄRKE: 25 mm;

AUSFÜHRUNGEN FÜR INSELMODUL

STRUKTUR DES INSELMODULS

MATERIAL: Holzagglomeratplatten mit niedriger Formaldehydabgabe (CARB);
STÄRKE: 30 mm;
AUSFÜHRUNG: Rau oder Rau lackiert;

ABDECKPLATTE AUS GLAS FÜR INSELMODUL

MATERIAL: gehärtetes Spiegelrauchglas;
STÄRKE: 8 mm;

AUSFÜHRUNGEN FÜR AUSSTATTUNG DER SCHRANKKABINE

HOLZFACHBÖDEN

MATERIAL: Holzagglomeratplatten mit niedriger Formaldehydabgabe (CARB);
STÄRKE: Fachboden 30 mm;
AUSFÜHRUNG: Rau oder Rau lackiert;
AUF ANFRAGE: Kleiderstange in Ausführung Aluminium Anthrazit oder Gris;
TRAGFÄHIGKEIT: Tragfähigkeit max. 40 kg;

ELEMENT RASTER

MATERIAL: Holzagglomeratplatten mit niedriger Formaldehydabgabe (CARB);
STÄRKE: Fachboden 30 mm, Trennwände und Rückwand 14 mm;
AUSFÜHRUNG: Rau oder Rau lackiert;
TRAGFÄHIGKEIT: Tragfähigkeit max. 30 kg;

BODENSTEHENDES SCHUBLADENELEMENT

MATERIAL: Holzagglomeratplatten mit niedriger Formaldehydabgabe (CARB);
STÄRKE: Fachboden 30 mm, Seitenwände 20 mm, Boden 14 mm, Rückwand 8 mm;
AUSFÜHRUNG: Rau oder Rau lackiert;

WANDHÄNGENDES SCHUBLADENELEMENT

MATERIAL: Holzagglomeratplatten mit niedriger Formaldehydabgabe (CARB);
STÄRKE: Fachboden 30 mm, Seitenwände 20 mm, Rückwand 14 mm;
BODEN: 14 mm;
AUSFÜHRUNG: Rau oder Rau lackiert;
TRAGFÄHIGKEIT: Tragfähigkeit max. 30 kg;

HOLZFRONTEN

MATERIAL: Holzagglomeratplatten mit niedriger Formaldehydabgabe (CARB);
STÄRKE: 20 mm;
AUSFÜHRUNG: Rau oder Rau lackiert; Griff oder Hohlkehle in Ausführung Aluminium Anthrazit oder Gris;

SCHUBLADENFRONTEN AUS GLAS

MATERIAL: gehärtetes Spiegelrauchglas;
STÄRKE: 4 mm;

INNENSTRUKTUR DER SCHUBLADEN

MATERIAL: Seitenwände aus Holzagglomerat mit Polymerbeschichtung, Komplett mit Laufschiene mit Aushaksicherung und gebremstem Einzugs;
STÄRKE: 14 mm;
BÖDEN: Holzagglomeratplatten mit niedriger Formaldehydabgabe (CARB)
STÄRKE: 14 mm;

HOSENHÄNGER/SCHUHABLAGE/HALTERUNGEN

MATERIAL: Ausführung Aluminium, Eisen, PVC in Ausführung Anthrazit oder Gris;

GLASFACHBODEN FÜR TABLETT

MATERIAL: gehärtetes Spiegelrauchglas;
STÄRKE: 4 mm;

KLEIDERLIFT

AUSFÜHRUNG: antracite o gris;
TRAGFÄHIGKEIT: Tragfähigkeit max. 10 kg;

SCHRANKKABINEN

AUSFÜHRUNGEN

MT 1/ONE Rau



MT CNV
Canvas



MT NAM
Nussbaum Bernstein

MT PREMIUM Rau matt



MT OC BG
Gipsweiß



MT OC MP
Perlmutter



MT OC ARN
Arena



MT OC BA
Basaltgrau

MT PREMIUM Rau Texture



MT ALP
Alpaca

MT PREMIUM Rau Holz



MT FO
Esche Oriente



MT RSB
Eiche Sand



MT RMK
Eiche Mokka



MT RT
Thermoeiche



MT RC
Eiche Kohlegrau

MT PREMIUM Rau astig



MT RNC
Astig hell

MT PREMIUM Rau Zement



MT CC
Zement hell



MT CV
Zement Cava



MT CS
Zement dunkel

Metallausführungen



Anthrazit



Gris

Gläser



601
Rauchglas

Profilausführungen DOORS



Brown

Gläser DOORS



601
Rauchglas



611
Rauchglas
satiniert



602
Bronzeoptik



612
Bronzeoptik
satiniert

SCHRANKKABINEN

AUSFÜHRUNGEN

Matte Lackierungen



121
Gipsweiß



162
Platin



124
Perlmutter



150
Hanfbeige



127
Hot Grau



178
Arena



130
Gris Piacenza



161
Schlamm



152
Bimsstein



163
Salzgrau



174
Rauchgrau



175
Lava



128
Smoke



160
Anthrazit



164
Schiefergrau



131
Rauchscharz



173
Eis



177
Basaltgrau



176
Bromo



155
Pastellblau



166
Mimetic Grün



167
Onyx



165
Myrte



168
Waldgrün



159
Salbeigrün



169
Kurkuma



158
Safrangelb



170
Terracotta



157
Pfirsich



172
Rubinrot



171
Tabasco



156
Bordeaux

BEIMÖBEL **ARGO ABDECKPLATTE ST. 6**



Öffnung mit seitlichem Griffvorsprung

	MT 1/ONE	MT PREMIUM						MT SPECIAL	LACKIERT			HOLZ
		Offenporig	Texture	Matt	Zement	Holz	Astig		Matt	Glänzend	Offenporig	
ABDECKPLATTE	•	•	•	•	•	•	•	•	•	•	•	•
FRONT	•	•	•	•	•	•	•	•	•	•	•	
STRUKTUR	•	•	•	•	•	•	•	•	•	•	•	

Ausführungen für Struktur, Fronten und Abdeckplatte

MT 1/ONE Rau	MT PREMIUM Rau matt	MT PREMIUM Rau Holz	MT SPECIAL Rau	LACKIERT
MT CNV Canvas MT NAM Nussbaum Bernstein	MT OC BG Gipsweiß MT OC MP Perlmutter MT OC ARN Arena MT OC BA Basaltgrau MT OC AN Anthrazit	MT RSB Eiche Sand MT FO Esche Oriente MT RMK Eiche Mokka MT RT Thermoeiche MT RC Eiche Kohlegrau	MT PSC Piasentina hell MT PSS Piasentina dunkel MT PB Stroh Bronze MT PG Stroh Grau MT GR Kies MT MB Maya Bronze MT OBR Oxid brüniert MT INT C Geflecht hell MT INT S Geflecht dunkel	OC Matt LC Glänzend PA Offenporig <p>Aufpreis für RAL-Lackierung +30%</p>
MT PREMIUM Rau offenporig lackiert	MT PREMIUM Rau Zement	MT PREMIUM Rau astig		
MT PA BG Gipsweiß MT PA MP Perlmutter	MT CC Zement hell MT CV Zement Cava MT CS Zement dunkel	MT RNN Astig Natur MT RNC Astig hell MT RNS Astig dunkel		
MT PREMIUM Rau Texture				
MT ALP Alpaca				

Die Abdeckplatte ist auch in folgenden Ausführungen lieferbar

HOLZ	
LGN RSB Eiche Sand	LGN RT Thermoeiche
LGN RMK Eiche Mokka	LGN RC Eiche Kohlegrau

BEIMÖBEL ARGO ABDECKPLATTE ST. 6

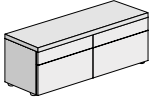
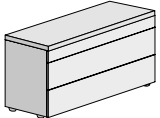
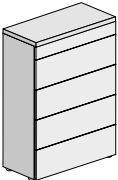
		Art.-Nr.	Ausführungen für Abdeckplatte	Ausführungen für Struktur und Fronten			
				MT 1/ONE	MT PREMIUM MT SPECIAL	OC-PA LACKIERT	LACKIERT LC
ANM.: Bei gemischten Ausführungen (Korpus abweichend von den Fronten) ist unter den beiden gewählten Varianten die höhere Preisklasse heranzuziehen.							
 <p>B. 59,2 - T. 40,3 - H. 46,1 cm Nachttisch 2 Schubladen</p> <p>kg 31,1 m³ 0,17</p>	3400120	MT 1/ONE	307	164,50	459	709	
		MT PREMIUM MT SPECIAL	340	400	493	743	
		OC-PA LACKIERT	358	418	511	760	
		HOLZ	410	471	563	813	
		LACKIERT LC	432	492	584	834	
 <p>B. 117,2 - T. 40,3 - H. 46,1 cm Nachttisch 4 Schubladen</p> <p>kg 62,2 m³ 0,34</p>	3400170	MT 1/ONE	552	588	753	1.105	
		MT PREMIUM MT SPECIAL	615	651	816	1.169	
		OC-PA LACKIERT	649	685	850	1.202	
		HOLZ	691	727	892	1.244	
		LACKIERT LC	769	805	970	1.322	
 <p>B. 134,3 - T. 51,7 - H. 75,3 cm Kommode 3 Schubladen</p> <p>kg 27 m³ 0,65</p>	3400700	MT 1/ONE	902	987	1.229	1.812	
		MT PREMIUM MT SPECIAL	992	1.077	1.319	1.902	
		OC-PA LACKIERT	1.117	1.203	1.445	2.028	
		HOLZ	1.137	1.222	1.464	2.047	
	<p>B. 134,3 - T. 51,7 - H. 75,3cm Kommode 3 Schubladen mit Abdeckplatte als Schreibpult</p>	3400701	LACKIERT LC	1.347	1.432	1.674	2.257
				+ 309	+ 309	+ 309	+ 309
 <p>B. 87 - T. 51,1 - H. 125,1 cm Hochkommode 5 Schubladen</p> <p>kg 106,5 m³ 0,7</p>	3400920	MT 1/ONE	707	853	1.319	1.854	
		MT PREMIUM MT SPECIAL	759	905	1.371	1.907	
		OC-PA LACKIERT	781	927	1.393	1.928	
		HOLZ	833	979	1.445	1.980	
		LACKIERT LC	937	1.083	1.549	2.084	



Abdeckplatte als Schreibpult

BEIMÖBEL ATHENA



Öffnung mit Hohlkehle.

	MT 1/ONE	MT PREMIUM						MT SPECIAL	LACKIERT		GLAS Glänzend	SPIEGEL	MOSAIK
		Offenporig	Texture	Matt	Zement	Holz	Astig		Matt	Offenporig			
ABDECKPLATTE	•	•		•	•	•	•		•	•			
FRONT	•	•		•	•	•	•		•	•			
STRUKTUR	•	•		•	•	•	•		•	•			
UNTERGRUND DER HOHLKEHLE	•	•	•	•	•	•	•	•	•	•	•	•	•

Ausführungen für Struktur und Untergrund der Hohlkehle

<p>MT 1/ONE Rau</p> <p>MT NAM Nussbaum Bernstein</p>	<p>MT PREMIUM Rau matt</p> <p>MT OC BG Gipsweiß</p> <p>MT OC MP Perlmutter</p>	<p>MT PREMIUM Rau Holz</p> <p>MT RMK Eiche Mokka</p>	<p>LACKIERT</p> <p>OC Matt Aufpreis für RAL-Lackierung +30%</p> <p>PA Offenporig</p>
<p>MT PREMIUM Rau offenporig lackiert</p> <p>MT PA BG Gipsweiß</p> <p>MT PA MP Perlmutter</p>	<p>MT PREMIUM Rau Zement</p> <p>MT CV Zement Cava</p>	<p>MT PREMIUM Rau astig</p> <p>MT RNC Astig hell</p>	

Der Untergrund der Hohlkehle ist auch in folgenden Ausführungen lieferbar

<p>MT 1/ONE Rau</p> <p>MT CNV Canvas</p>	<p>MT PREMIUM Rau Zement</p> <p>MT CC Zement hell</p> <p>MT CS Zement dunkel</p>	<p>MT PREMIUM Rau astig</p> <p>MT RNN Astig Natur</p> <p>MT RNS Astig dunkel</p>	<p>MT SPECIAL Rau</p> <p>MT PSC Piasentina hell MT MB Maya Bronze</p> <p>MT PSS Piasentina dunkel MT OBR Oxid brüniert</p> <p>MT PB Stroh Bronze MT INT C Geflecht hell</p> <p>MT PG Stroh Grau MT INT S Geflecht dunkel</p> <p>MT GR Kies</p>	
<p>MT PREMIUM Rau matt</p> <p>MT OC ARN Arena</p> <p>MT OC BA Basaltgrau</p> <p>MT OC AN Anthrazit</p>	<p>MT PREMIUM Rau Holz</p> <p>MT RSB Eiche Sand</p> <p>MT FO Esche Oriente</p> <p>MT RT Thermoeiche</p> <p>MT RC Eiche Kohlegrau</p>	<p>MOSAIK</p> <p>Brown Marrón</p> <p>Silver</p> <p>Grey</p>	<p>SPIEGEL</p> <p>383 Grauer Spiegel</p>	<p>GLAS</p> <p>LC Glänzend</p>

BEIMÖBEL ATHENA

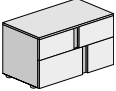
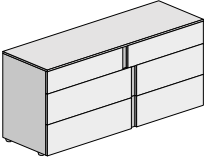
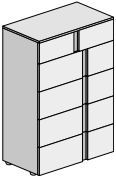
		Abmessungen	Art.-Nr.	MT 1/ONE	MT PREMIUM	OC-PA LACKIERT	
	T. 40,4 - H. 42,7 cm	B. 44,2 cm	kg 23,9 m³ 0,098	340023	403	436	516
	Nachtisch 2 Schubladen	B. 60,2 cm	kg 32,5 m³ 0,131	3400123	403	436	516
		B. 88,2 cm	kg 47,6 m³ 0,187	3400223	475	514	584
	Bausatz Beleuchtungsanlage (mit Schalter auf der Seitenwand, die Lage rechts oder links angeben)				117	117	117
Aufpreis für Fernbedienung ON/OFF (ACHTUNG: nur für 230V)				+ 156	+ 156	+ 156	
	T. 51,4 - H. 70,1 cm	B. 126,5 cm	kg 84,9 m³ 0,539	3400603	962	1.111	1.383
	Kommode 3 Schubladen						
	Bausatz Beleuchtungsanlage (mit Schalter auf der Seitenwand, die Lage rechts oder links angeben)				117	117	117
Aufpreis für Fernbedienung ON/OFF (ACHTUNG: nur für 230V)				+ 156	+ 156	+ 156	
	T. 51,4 - H. 108,7 cm	B. 60,2 cm	kg 65,2 m³ 0,403	3400823	971	1.054	1.260
	Hochkommode 5 Schubladen	B. 88,2 cm	kg 95,5 m³ 0,578	3400923	1.162	1.261	1.503
	Bausatz Beleuchtungsanlage (mit Schalter auf der Seitenwand, die Lage rechts oder links angeben)				117	117	117
	Aufpreis für Fernbedienung ON/OFF (ACHTUNG: nur für 230V)				+ 156	+ 156	+ 156



ANM.: Immer die Ausführung für den Untergrund des Griffprofils angeben.

Zusätzliches Set Untergründe

	Holz und Glas
Nachtisch	+ 47
Kommode	+ 74
Hochkommode	+ 120

BEIMÖBEL VINCI

Öffnung mit Griffprofil.



	MT 1/ONE	MT PREMIUM						MT SPECIAL	LACKIERT		HOLZFURNIER	SPIEGEL
		Offenporig	Texture	Matt	Zement	Holz	Astig		Matt	Offenporig		
ABDECKPLATTE	•	•	•	•	•	•	•	•	•			
FRONT	•	•	•	•	•	•	•	•	•	•	•	
STRUKTUR	•	•	•	•	•	•	•	•	•			
RAHMEN								•				

Ausführungen für Struktur und Fronten

MT 1/ONE Rau	MT PREMIUM Rau matt	MT PREMIUM Rau Holz	MT SPECIAL Rau	LACKIERT
<p>MT CNV Canvas</p> <p>MT NAM Nussbaum Bernstein</p>	<p>MT OC BG Gipsweiß</p> <p>MT OC MP Perlmutter</p> <p>MT OC ARN Arena</p> <p>MT OC BA Basaltgrau</p> <p>MT OC AN Anthrazit</p>	<p>MT RSB Eiche Sand</p> <p>MT FO Esche Oriente</p> <p>MT RMK Eiche Mokka</p> <p>MT RT Thermoeiche</p> <p>MT RC Eiche Kohlegrau</p>	<p>MT PSC Piasentina hell</p> <p>MT PSS Piasentina dunkel</p> <p>MT PB Stroh Bronze</p> <p>MT PG Stroh Grau</p> <p>MT GR Kies</p> <p>MT MB Maya Bronze</p> <p>MT OBR Oxid brüniert</p> <p>MT INT C Geflecht hell</p> <p>MT INT S Geflecht dunkel</p>	<p>OC Matt</p> <p>PA Offenporig</p> <p>Aufpreis für RAL- Lackierung +30%</p>
MT PREMIUM Rau offenporig lackiert	MT PREMIUM Rau Zement	MT PREMIUM Rau astig		
<p>MT PA BG Gipsweiß</p> <p>MT PA MP Perlmutter</p>	<p>MT CC Zement hell</p> <p>MT CV Zement Cava</p> <p>MT CS Zement dunkel</p>	<p>MT RNN Astig Natur</p> <p>MT RNC Astig hell</p> <p>MT RNS Astig dunkel</p>		
MT PREMIUM Rau Texture				
<p>MT ALP Alpaca</p>				

Rahmenausführungen

LACKIERT
<p>OC Matt</p>

Die Front ist auch in folgenden Ausführungen lieferbar

SPIEGEL	
<p>383 Grauer Spiegel</p>	<p>383 Spiegel in Bronzeoptik</p>

Die Ausführungen sind nur für die erste Schublade lieferbar

HOLZ	
<p>LGN CRSB Eiche Sand „Canettè“</p> <p>LGN NC Nussbaum „Canettè“</p>	<p>LGN CRMK Eiche Mokka „Canettè“</p> <p>LGN CRC Eiche Kohlegrau „Canettè“</p>

Typen- und Preisliste

BEIMÖBEL VINCI

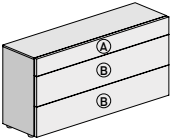
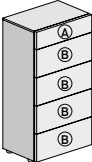
	Struktur	Art.-Nr.	MT 1/ONE	MT PREMIUM	OC-PA LACKIERT
			MT 1/ONE	MT PREMIUM	OC-PA LACKIERT SPIEGEL
 B. 59,2 - T. 41,2 - H. 42,1 cm Nachttisch 2 Schubladen 3400032			559	612	705
		Ⓐ HOLZ	+ 134	+ 134	+ 117
	AUFPREIS pro Front	Ⓐ LACKIERT SPIEGEL	+ 17	+ 17	-
		Ⓑ LACKIERT SPIEGEL	+ 28	+ 28	-
kg 33 m³ 0,128					
 B. 134,5 - T. 52,6 - H. 70,4 cm Kommode 3 Schubladen 3400612			1.316	1.422	1.701
		Ⓐ HOLZ	+ 270	+ 270	+
	AUFPREIS pro Front	Ⓐ LACKIERT SPIEGEL	+ 42	+ 42	227
		Ⓑ LACKIERT SPIEGEL	+ 61	61	-
kg 84 m³ 0,545					
 B. 59,2 - T. 52,6 - H. 115 cm Hochkommode 5 Schubladen 3400832			1.383	1.497	1.739
		Ⓐ HOLZ	+ 134	+ 134	+ 117
	AUFPREIS pro Front	Ⓐ LACKIERT SPIEGEL	+ 17	+ 17	-
		Ⓑ LACKIERT SPIEGEL	+ 28	+ 28	-
kg 48 m³ 0,405					



ANM.: Immer die Ausführungen der Profile OC Farbe matt angeben

Contur

Typen- und Preisliste

BETTEN

JOKER

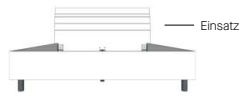

FüÙe serienmÙÙig in AusfÙhrung Anthrazit (4 StÙck)

€ +0 Ausführung ANTRAZIT

€ + 161 Ausführung Farbe matt / Bettrahmen

AusfÙhrungen fÙr Struktur und Einsatz

ZusÙtzliche AusfÙhrungen fÙr Einsatz

MT PREMIUM
Rau matt

 **MT OC BG**
GipsweiÙ

 **MT OC MP**
Perlmutter

MT PREMIUM
Rau astig

 **MT RNN**
Astig
Natur

 **MT RNC**
Astig
hell

MT PREMIUM
Rau Texture

 **MT ALP**
Alpaca

LACKIERT

 **OC**
Matt

Aufpreis fÙr
RAL-Lackierung +30%

Typen- und Preisliste

JOKER

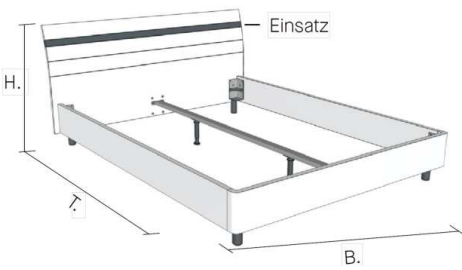
		Maße Lattenrost / Bett	Art.-Nr.	MT PREMIUM	LACKIERT OC
Bettrahmen					
	160 x 200 cm B. 176 - T. 215,6 - H. 96,8 cm	36040713GR	1.026	1.238	
	160 x 210 cm B. 176 - T. 225,6 - H. 96,8 cm	36040717GR	1.104	1.316	
	180 x 200 cm B. 196 - T. 215,6 - H. 96,8 cm	36040743GR	1.026	1.238	
	180 x 210 cm B. 196 - T. 225,6 - H. 96,8 cm	36040747GR	1.104	1.316	
kg 63,55 m ³ 0,32					



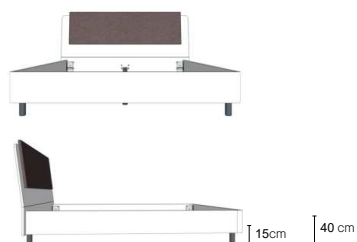



ROXY



Füße serienmäßig in Ausführung Anthrazit (4 Stück)

€ +0	Ausführung ANTRAZIT
€ +72	Ausführung Farbe matt / Bettrahmen

Ausführungen für Struktur und Einsatz Zusätzliche Ausführungen für Einsatz

MT PREMIUM Rau matt	MT PREMIUM Rau astig	MT PREMIUM Rau Texture	LACKIERT
 MT OC BG Gipsweiß  MT OC MP Perlmutter	 MT RNN Astig Natur  MT RNC Astig hell	 MT ALP Alpaca	 OC Matt Aufpreis für RAL-Lackierung +30%

Typen- und Preisliste

ROXY

Bettrahmen

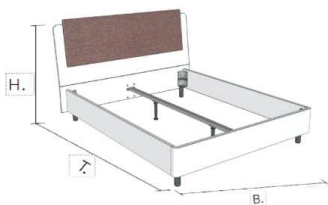

kg 51,41
m³ 0,19

Maße Lattenrost / Bett	Art.-Nr.	Ausführung Struktur	Einsatz auf Kopfteil	
			MT PREMIUM	LACKIERT OC
160 x 200 cm B. 182 - T. 215,8 - H. 96cm	36046913GR	MT PREMIUM	1.594	1.611
160 x 210 cm B. 182 - T. 225,8 - H. 96cm	36046917GR	LACKIERT OC	1.628	1.650
180 x 200 cm B. 202 - T. 219 - H. 96 cm	36046943GR	MT PREMIUM	1.594	1.611
180 x 210 cm B. 215 - T. 229 - H. 96 cm	36046947GR	LACKIERT OC	1.628	1.650

TABLET

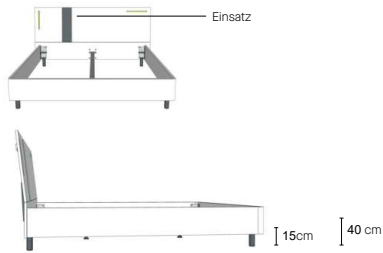







Füße serienmäßig in Ausführung Anthrazit (4 Stück)

€ +0 Ausführung Gipsweiß / Perlmutter

€ +72 Ausführung Farbe matt / Bettrahmen

Ausführungen für Struktur und Einsatz Zusätzliche Ausführungen für Einsatz

MT PREMIUM Rau matt	MT PREMIUM	MT PREMIUM Rau Texture	LACKIERT
 MT OC BG Gipsweiß  MT OC MP Perlmutter	Rau astig  MT RNN Astig Natur  MT RNC Astig hell	 MT ALP Alpaca	 OC Matt Aufpreis für RAL-Lackierung +30%

Typen- und Preisliste

TABLET

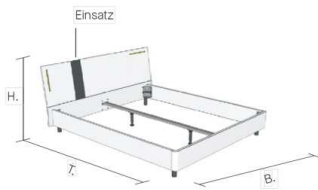
	Maße Lattenrost / Bett	Art.-Nr.	MT PREMIUM	LACKIERT OC-PA
Bettrahmen				
	160 x 200 cm B. 182 - T. 215,8 - H. 90,6 cm	36040913GR	1.082	1.360
	160 x 210 cm B. 182 - T. 225,8 - H. 90,6m	36040917GR	1.115	1.399
	180 x 200 cm B. 202 - T. 215,8 - H. 90,6 cm	36040943GR	1.082	1.360
	180 x 210 cm B. 202 - T. 21v5,8 - H. 90,6 cm	36040947GR	1.115	1.399
kg 44,86 m³ 0,15				

GEMINI H25



15cm 40cm







Bett mit verstellbaren Halterungen für Lattenroste in anderen Stärken vorgesehen

- € +240 Breitenkürzung
- € +240 Abänderung der Bettseiten in der Tiefe nur bei Lattenrost T. 215 cm
- +15% Aufpreis auf Anfrage für Bett mit ausgefertigter Rückseite



Füße in Ausführung Anthrazit oder Gipsweiß (4 Stück)

WOOD	TOWER	VICTOR	GINGER	BLADE
				
serienmäßig	€ +141	€ +62	€ +141	€ +62

Ausführungen für Struktur und Einsatz Zusätzliche Ausführungen für Einsatz

MT PREMIUM Rau matt	MT PREMIUM Rau astig	MT PREMIUM Rau Texture	LACKIERT
 MT OC BG Gipsweiß  MT OC MP Perlmutter	 MT RNN Astig Natur  MT RNC Astig hell	 MT ALP Alpaca	 OC Matt Aufpreis für RAL-Lackierung +30%

Bezüge für Kopfteilkissen

STOFFE DER MUSTERKARTE	
	1/ONE Easy / Selfie / Lederimitat Surround / Kundenstoff A Boston / Rinnova / Swing / Cotton club B Daytona / Lederimitat: Extrema, Eve, Vintage / Econabuk / Venice C Allure unito / Allure coordinato / Sancho / Linara / Lino Froissé
	Für Ersatzbezüge und Stoffmengen siehe Seite 236

ECONABUK UND LEDERIMITAT

 Für zusätzliche Zertifizierung der Feuerbeständigkeit siehe Seite 242

Typen- und Preisliste

GEMINI H25

Bettrahmen

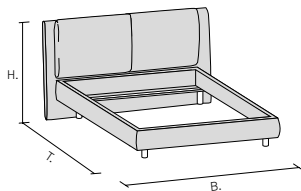

Maße Lattenrost / Bett	Art.-Nr.	Ausführung Struktur	Bezug für Einsatz auf Kopfteil			
			1/ONE	A	B	C
160 x 200 cm B. 182 - T. 215,8 - H. 96cm	36046913GR	MT PREMIUM	1.070	1.114	1.181	1.259
160 x 210 cm B. 182 - T. 225,8 - H. 96cm	36046917GR	LACKIERT OC	1.434	1.477	1.544	1.622
180 x 200 cm B. 202 - T. 219 - H. 96 cm	36046943GR	MT PREMIUM	1.070	1.114	1.181	1.259
180 x 21 cm B. 215 - T. 229 - H. 96 cm	36046947GR	LACKIERT OC	1.434	1.477	1.544	1.622

kg 59,7
m³ 0,46

ZUSATZELEMENTE KALISTA

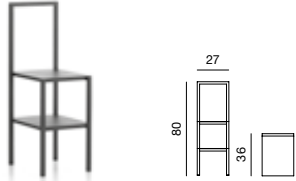
LACKIERT OC	B.	T.	Art.-Nr.	LACKIERT OC
KALISTA Beistelltisch mit Struktur aus Metall H. 80 cm				
	27 cm	36 cm	kg 10 m² 0,11 020M9500	120,00

ZUSATZELEMENTE

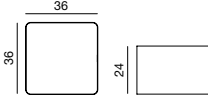
MT 1/ONE MT CNV MT NAM	MT PREMIUM MT PA BG MT PA MP MT OC BG MT OC MP MT OC ARN	MT OC BA MT OC AN MT ALP MT RSB MT FO	MT RMK MT RT MT RC MT RNN MT RNC	MT RNS MT CC MT CV MT CS	MT SPECIAL MT PSC MT PSS MT PB MT PG	MT MB MT OBR	LACKIERT OC PA	METALLIC-LACKIERUNG OCM	Rückwand		
				B.	H.	Art.-Nr.		MT 1/ONE MT PREMIUM MT SPECIAL	LACKIERT OC-PA	GRAPHIC / SPIEGEL / LACKIERT OCM	
CIKO Hängeelement T. 24 cm											
		Struktur Farbe Anthrazit		36 cm	36 cm	kg 26 m² 0,011	0204700	268	337	337	
		Struktur matt lackiert						268	337	337	
											

SCHREIBPULT

MT 1/ONE MT CNV MT NAM	MT PREMIUM MT PA BG MT PA MP MT OC BG MT OC MP MT OC ARN	MT OC BA MT OC AN MT ALP MT RSB MT FO	MT RMK MT RT MT RC MT RNN MT RNC	MT RNS MT CC MT CV MT CS	LACKIERT OC PA	Schreibpultplatte und Trennwände				
				B.	T.	Art.-Nr.		MT 1/ONE	MT PREMIUM	LACKIERT OC-PA
ATLANTE Schreibpult Atlante mit Element Raster H. 87,7 cm										
		Beine und Raster aus Metall matt lackiert		120 cm	70 cm	kg 52,5 m² 0,2191	4016386R	748	789	928
										

SITZMÖBEL



STOFFE DER MUSTERKART

1/ONE Easy / Selfie / Ecopelle Surround / Kundenstoff
A Boston / Rinnova / Swing / Cotton club
B Daytona / Lederimitat: Extrema, Eve, Vintage / Econabuk / Venice
C Allure unito / Allure coordinato / Sancho / Linara / Lino Froissé
E Leder: Fiore
F Leder: Montana, Nabuk, Vintage

HOLZ
LGN RSB
LGN RMK
LGN RC

	B.	T.	Art.-Nr.	1/One	A	B	C	E	F	
LOFT Sessel nicht abziehbar H 64 cm										
	59 cm	70 cm	kg 14 m ² 0,31	02012201	1.213	1.244	1.360	1.407	1.718	2.103
Struktur aus Holz										
Erforderliche Stoffmenge Lfm. 1,8										
LOFT Sessel nicht abziehbar H. 70 cm										
	65 cm	75 cm	kg 17 m ² 0,31	02012202	1.307	1.342	1.432	1.518	1.861	2.284
Struktur aus Holz										
				1.170,00						
Erforderliche Stoffmenge Lfm. 2,2										
SOFT Sessel abziehbar H. 72 cm										
	66 cm	95 cm	kg 11 m ² 0,45	02012502	1.165	1.219	1.347	1.472	2.005	2.609
Struktur aus Holz										
Erforderliche Stoffmenge Lfm. 3,2										
GUCCINO Hocker mit Stauraum, Platte matt lackiert (nicht abziehbar in Kat. E/F) H. 53 cm										
	Ø 40 cm		kg 7,6 m ³ 0,1	02012010	574	589	621	651	757	905
Erforderliche Stoffmenge Lfm. 1										

Contur







Typen- und Preisliste

BEISTELLTISCHE

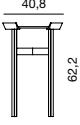

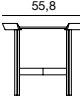
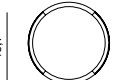

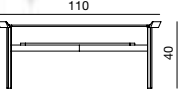
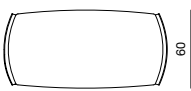

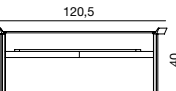
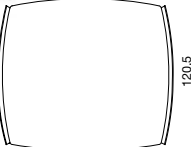
Typen- und Preisliste

BEISTELLTISCHE BLOOM

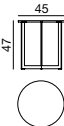
GRES ELEGANCE		GRES PREMIUM		GLAS	HOLZ				
012 Pietra Antracite	034 Urban Marble	040 Calacatta oro	070 Calatorao silk	320 Transparentes Glas	LGN RSB				
032 Fokos Terra	035 Amani	041 Noir desir	071 Abu dhabi silk		LGN RMK				
033 Fokos Piombo		042 Emperador	072 Pulpis silk		LGN RC				
		043 Nero greco							
	B.	T.		Art.-Nr.	GLAS	GRES ELEGANCE	GRES PREMIUM		
BLOOM Runder Beistelltisch mit Platte aus transparentem Glas oder Gres H. 62,2 cm									
			Struktur aus Holz	Ø 40,8 cm	kg 15 m³ 0,09	0200020B	399	546	568
BLOOM Runder Beistelltisch mit Platte aus transparentem Glas oder Gres H. 46,7 cm									
			Struktur aus Holz	Ø 55,8 cm	kg 17 m³ 0,12	0200021B	455	637	681
BLOOM Rechteckiger Beistelltisch Bloom mit Platte aus transparentem Glas H. 40 cm									
			Struktur aus Holz	110 cm	60 cm	kg 24 m³ 0,35	0200322B	992	-
BLOOM Quadratischer Beistelltisch Bloom mit Platte aus transparentem Glas H. 40 cm									
			Struktur aus Holz	120,5 cm	120,5 cm	kg 28 m³ 0,53	0200123B	1.510	-

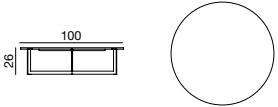

BEISTELLTISCHE JOY

MT 1/ONE MT CNV MT NAM		MT PREMIUM MT PA BG MT OC BA MT PA MP MT OC AN MT OC BG MT ALP MT OC MP MT RSB MT OC ARN MT FO				MT RMK MT RT MT RC MT RNN MT RNC				MT RNS MT CC MT CV MT CS		MT SPECIAL MT PSC MT PSS MT PB MT PG MT GR			MT MB MT INT C MT INT S MT OBR		LACKIERT OC PA LC		METALLIC-LACKIERUNG OCM	
B.		Art.-Nr.		MT 1/ONE	MT PREMIUM MT SPECIAL	LACKIERT OC-PA	LACKIERT OCM	LACKIERT LC												
JOY Beistelltisch mit Holzplatte und Metallstruktur H. 47 cm																				
		Struktur Farbe Anthrazit	Ø 45 cm	kg 4,15 m³ 0,12	0200001	262	271	290	318	377										
		Struktur matt lackiert				312	322	340	368	427										
JOY Beistelltisch mit Holzplatte und Metallstruktur H. 39 cm																				
		Struktur Farbe Anthrazit	Ø 60 cm	kg 5,7 m³ 0,17	0200003	318	333	368	407	489										
		Struktur matt lackiert				349	363	398	437	520										
JOY Beistelltisch mit Holzplatte und Metallstruktur H. 26 cm																				
		Struktur matt lackiert	Ø 100 cm	kg 13,67 m³ 0,30	0200005	572	613	756	832	990										

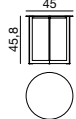

Typen- und Preisliste

BEISTELLTISCHE JOY DECOR

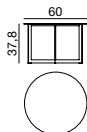
LACKIERT
0C

		B.	Art.-Nr.	AUSFÜHRUNG ANTHRAZIT	METALL LACKIERT 0C	GRAPHIC
JOY DECOR Beistelltisch mit Platte und Struktur aus Metall H. 45,8 cm						
 	Struktur Farbe Anthrazit	Ø 45 cm kg 4,8 m³ 0,118	0200001	270	290	318
	Struktur matt lackiert			322	340	368
JOY DECOR Beistelltisch mit Platte und Struktur aus Metall H. 37,8 cm						
 	Struktur Farbe Anthrazit	Ø 60 cm kg 5,8 m³ 0,166	0200003	333	368	407
	Struktur matt lackiert			363	398	437

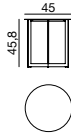
BEISTELLTISCHE JOY WOOD

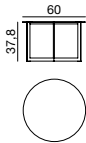
		B.	Art.-Nr.	NOGAL NEGRO	ROBLE
JOY WOOD Beistelltisch mit Struktur aus Metall und Platte aus Metall und furniertem Holz H. 45,8 cm					
 	Struktur Farbe Anthrazit	Ø 45 cm kg 4,8 m ² 0,118	0200001	379	-
	Struktur matt lackiert			430	-
JOY WOOD Beistelltisch mit Struktur aus Metall und Platte aus Metall und furniertem Holz H. 37,8 cm					
 	Struktur Farbe Anthrazit	Ø 60 cm kg 5,8 m ² 0,166	0200003	-	450
	Struktur matt lackiert			-	481

BEISTELLTISCHE JOY GRES

GRES ELEGANCE





012 Pietra Antracite
032 Fokos Terra
033 Fokos Piombo

034 Urban Marble
035 Amani

GRES PREMIUM

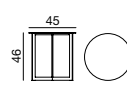
040 Calacatta oro
041 Noir desir
042 Emperador
043 Nero greco

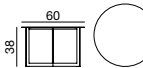

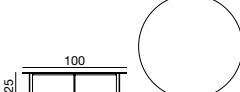



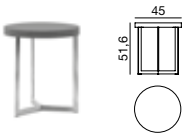
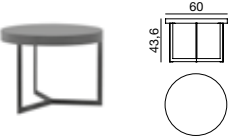
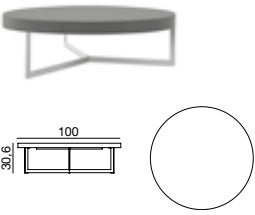

070 Calatarao silk
071 Abu Dhabi silk
072 Pulpis silk

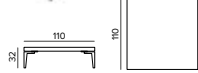
		B.	Art.-Nr.	GRES ELEGANCE	GRES PREMIUM
JOY Bestelltisch mit Platte aus Gres und Struktur aus Metall H. 46 cm					
 	Struktur Farbe Anthrazit	Ø 45 cm kg 5,2 m ² 0,12	0200001	363	403
	Struktur matt lackiert			414	453
JOY Bestelltisch mit Platte aus Gres und Struktur aus Metall H. 38 cm					
 	Struktur Farbe Anthrazit	Ø 60 cm kg 6,1 m ² 0,17	0200003	466	533
	Struktur matt lackiert			496	563
JOY Bestelltisch mit Platte aus Gres und Struktur aus Metall H. 25 cm					
 	Struktur matt lackiert	Ø 100 cm kg 14 m ² 0,3	0200005	933	1.119

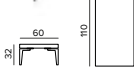

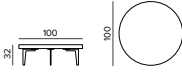
BEISTELLTISCHE JOY PLUS

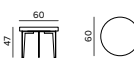
MT 1/ONE MT CNV MT NAM		MT PREMIUM MT PA BG MT OC BA MT RMK MT RNS MT PA MP MT OC AN MT RT MT CC MT OC BG MT ALP MT RC MT CV MT OC MP MT RSB MT RNN MT CS MT OC ARN MT FO MT RNC				MT SPECIAL MT PSC MT MB MT PSS MT INT C MT PB MT INT S MT PG MT OBR MT GR		LACKIERT OC PA LC	METALLIC-LACKIERUNG OCM		
B.	Art.-Nr.	MT 1/ONE	MT PREMIUM MT SPECIAL	LACKIERT OC-PA	LACKIERT OCM	LACKIERT LC					
<p>JOY Beistelltisch mit Holzplatte und Metallstruktur H. 51,6 cm</p>  <p>Struktur Farbe Anthrazit Ø 45 cm kg 11 Struktur matt lackiert m³ 0,14</p> <p>0200001</p>							294	316	420	474	495
							345	363	472	524	545
<p>JOY Beistelltisch mit Holzplatte und Metallstruktur H. 43,6 cm</p>  <p>Struktur Farbe Anthrazit Ø 60 cm kg 17,5 Struktur matt lackiert m³ 0,19</p> <p>0200003</p>							361	391	559	632	658
							391	428	589	662	687
<p>JOY Beistelltisch mit Holzplatte und Metallstruktur H. 30,6 cm</p>  <p>Struktur matt lackiert Ø 100 cm kg 46,5 m³ 0,35</p> <p>0200005</p>							717	818	1.187	1.349	1.360

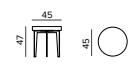
BEISTELLTISCHE ATOLLO

MT 1/ONE MT CNV MT NAM		MT PREMIUM MT PA BG MT PA MP MT OC BG MT OC MP MT OC ARN				MT OC BA MT OC AN MT ALP MT RSB MT FO		MT RMK MT RT MT RC MT RNN MT RNC		MT RNS MT CC MT CV MT CS		MT SPECIAL MT PSC MT PSS MT PB MT PG		MT MB MT OBR		LACKIERT OC PA LC		METALLIC-LACKIERUNG OCM	
B.	T.	Art.-Nr.				MT 1/ONE	MT PREMIUM MT SPECIAL	LACKIERT OC-PA	LACKIERT OCM	LACKIERT LC									
ATOLLO Quadratischer Beistelltisch mit Struktur aus Metall H. 32 cm																			
		Struktur matt lackiert		110 cm	110 cm	kg 36,67 m³ 0,25	0200115	524	643	830	931	1.018							
																			
ATOLLO Rechteckiger Beistelltisch mit Struktur aus Metall H. 32 cm																			
		Struktur matt lackiert		60 cm	110 cm	kg 60,23 m³ 0,44	0200313	442	508	609	665	910							
																			
ATOLLO Runder Beistelltisch mit Struktur aus Metall H. H. 32 cm																			
		Struktur aus matt lackiertem Metall		Ø 100 cm		kg 49,14 m³ 0,37	0200015	591	695	1.061	1.222	1.232							
																			
ATOLLO Runder Beistelltisch mit Struktur aus Metall H. H. 47 cm																			
		Struktur aus matt lackiertem Metall		Ø 60 cm		kg 17,52 m³ 0,20	0200013	556	593	754	827	853							
																			
ATOLLO Runder Beistelltisch mit Struktur aus Metall H. H. 47 cm																			
		Struktur matt lackiert		Ø 45 cm		kg 10,77 m³ 0,12	0200011	444	465	568	623	643							
																			

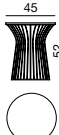
BEISTELLTISCHE BRIGITTE - ECLISSE

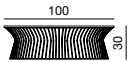
MT 1/ONE MT CNV MT NAM		MT PREMIUM MT PA BG MT OC BA MT PA MP MT OC AN MT OC BG MT ALP MT OC MP MT RSB MT OC ARN MT FO				MT RMK MT RT MT RC MT RNN MT RNC			MT RNS MT CC MT CV MT CS		MT SPECIAL MT PSC MT PSS MT PB MT PG MT GR			MT MB MT INT C MT INT S MT OBR		LACKIERT OC PA LC		METALLIC-LACKIERUNG OCM		
		B.		T.		Art.-Nr.		MT 1/ONE	MT PREMIUM MT SPECIAL	LACKIERT OC-PA	LACKIERT OCM	LACKIERT LC								
BRIGITTE Runder Beistelltisch für den Wohnraum mit Struktur aus Metall H. 52 cm																				
				Struktur matt lackiert		Ø 45 cm	kg 9,46 m² 0,125	0200007E	650	660	689	708	769							
BRIGITTE Runder Beistelltisch für den Wohnraum mit Struktur aus Metall H. 30 cm																				
				Struktur matt lackiert		Ø 100 cm	kg 22,7 m² 0,352	0200009E	1.735	1.778	1.926	2.001	2.233							

PANKETTA - UP & DOWN - LETTERING

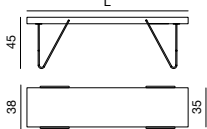
MT 1/ONE MT CNV MT NAM		MT PREMIUM MT PA BG MT OC BA MT PA MP MT OC AN MT OC BG MT ALP MT OC MP MT RSB MT OC ARN MT FO				MT RMK MT RT MT RC MT RNN MT RNC			MT RNS MT CC MT CV MT CS		MT SPECIAL MT PSC MT PSS MT PB MT PG MT GR			MT MB MT OBR		LACKIERT OC PA		METALLIC-LACKIERUNG OCM		
		B.		T.		Art.-Nr.		MT 1/ONE	MT PREMIUM MT SPECIAL	LACKIERT OC-PA	LACKIERT OCM									
PANKETTA H 45 cm																				
				Struktur matt lackiert		144 cm	38 cm	kg 0,05 m² 0,24	0205407	543	550	641	697							
						180 cm	38 cm	kg 0,06 m² 0,28	0205409	572	581	695	759							
						216 cm	38 cm	kg 0,07 m² 0,33	0205411	574	592	728	802							

Typen- und Preisliste

GRAFIKMUSTER FÜR PLATTE JOY

VINCI

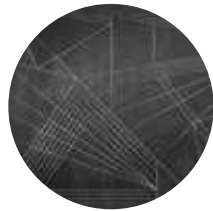

102

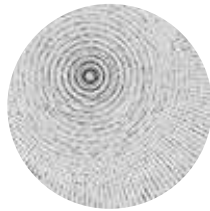

103



104

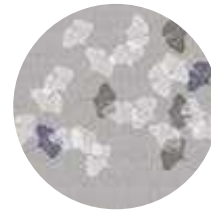

107



109



111



112

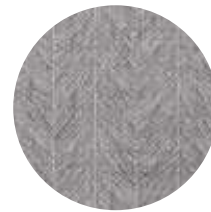

113

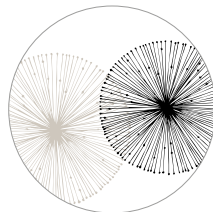

138

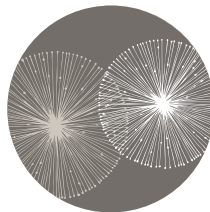

139



150



1001



1002

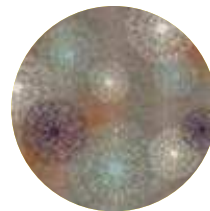

1003



1004



1005

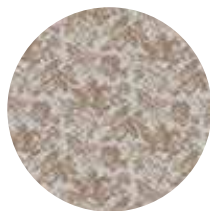

1007



1008



1009



1010



1011



1012



1013

Ausführungen

Die Ausführungen und Farben sind rein hinweisend und können je nach Drucktechnik leichte Abweichungen aufweisen.

GRES ELEGANCE



012
Pietra Antracite



032
Fokos Terra



033
Fokos Piombo



034
Urban Marble



035
Amani

GRES PREMIUM



040
Calacatta oro



041
Noir desir



042
Emperador

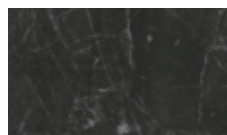

043
Nero greco



070
Calatorao silk



071
Abu Dhabi silk



072
Pulpis silk

Ausführungen

MT 1/ONE
Rau

 **MT CNV**
Canvas

 **MT NAM**
Nussbaum Bernstein

MT PREMIUM
Rau offenporig lackiert

 **MT PA BG**
Gipsweiß

 **MT PA MP**
Perlmutter

MT PREMIUM
Rau matt

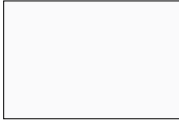
 **MT OC BG**
Gipsweiß

 **MT OC MP**
Perlmutter

 **MT OC ARN**
Arena

 **MT OC BA**
Basaltgrau

 **MT OC AN**
Anthrazit

MT PREMIUM
Rau Holz

 **MT RSB**
Eiche Sand

 **MT FO**
Esche Oriente

 **MT RMK**
Eiche Mokka

 **MT RT**
Thermoeiche

 **MT RC**
Eiche Kohlegrau

MT PREMIUM
Rau Texture

 **MT ALP**
Alpaca

MT PREMIUM
Rau Zement

 **MT CC**
Zement hell

 **MT CV**
Zement Cava

 **MT CS**
Zement dunkel























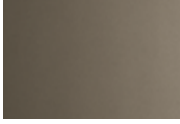

MT PREMIUM
Rau astig

 **MT RNN**
Astig Natur

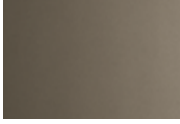
 **MT RNC**
Astig hell

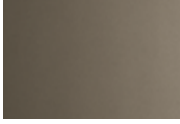















 **MT RNS**
Astig dunkel

Ausführungen

MT SPECIAL Rau		HOLZ		HOLZ CANETTÉ									
	MT PSC Piasentina hell		LGN RSB Eiche Sand		LGN CRSB Eiche Sand „Canetté“								
	MT PSS Piasentina dunkel		LGN RMK Eiche Mokka		LGN CRMK Eiche Mokka „Canetté“								
	MT PB Stroh Bronze		LGN RT Thermoeiche		LGN CRC Eiche Kohlegrau „Canetté“								
	MT PG Stroh Grau		LGN RC Eiche Kohlegrau										
	MT GR Kies			<table border="1"> <thead> <tr> <th colspan="2">CANETTÉ</th> </tr> </thead> <tbody> <tr> <td></td> <td>OCC Farbig lackiertes</td> </tr> </tbody> </table>		CANETTÉ			OCC Farbig lackiertes				
CANETTÉ													
	OCC Farbig lackiertes												
	MT MB Maya Bronze			<table border="1"> <thead> <tr> <th colspan="2">METALLIC-LACKIERUNG</th> </tr> </thead> <tbody> <tr> <td></td> <td>OCM 190 Bronzeoptik</td> </tr> <tr> <td></td> <td>OCM 191 Gusseisen</td> </tr> <tr> <td></td> <td>OCM 192 Messing</td> </tr> </tbody> </table>		METALLIC-LACKIERUNG			OCM 190 Bronzeoptik		OCM 191 Gusseisen		OCM 192 Messing
METALLIC-LACKIERUNG													
	OCM 190 Bronzeoptik												
	OCM 191 Gusseisen												
	OCM 192 Messing												
	MT OBR Oxid brüniert												
	MT INT C Geflecht hell												
	MT INT S Geflecht dunkel												

Ausführungen

Die Ausführungen und Farben sind rein hinweisend und können je nach Drucktechnik leichte Abweichungen aufweisen.

				
	Gipsweiß	Platin	Perlmutter	Hanfbeige
Matt lackiert	121	162	124	150
Glänzend lackiert	121	162	124	150
Offenporig	221	262	224	250
Glänzendes Glas	321	362	324	350
Satiniertes Glas	421	462	424	450
				
	Hot Grau	Arena	Gris Piacenza	Schlamm
Matt lackiert	127	178	130	161
Glänzend lackiert	127	178	130	161
Offenporig	227	278	230	261
Glänzendes Glas	327	378	330	361
Satiniertes Glas	427	478	430	461
				
	Bimsstein	Salzgrau	Rauchgrau	Lava
Matt lackiert	152	163	174	175
Glänzend lackiert	152	163	174	175
Offenporig	252	263	274	275
Glänzendes Glas	352	363	374	375
Satiniertes Glas	452	463	474	475
				
	Smoke	Anthrazit	Schiefergrau	Rauchschwarz
Matt lackiert	128	160	164	131
Glänzend lackiert	128	160	164	131
Offenporig	228	260	264	231
Glänzendes Glas	328	360	364	331
Satiniertes Glas	428	460	464	431

Ausführungen

Beispiel mit Perlmutter



124
Cod. 100
für matte und glänzende
Lackierungen



224
Cod. 200
für offenporige
Lackierungen



324
Cod. 300
glänzende Gläser



424
Cod. 400
satinierte Gläser



Eis



Basaltgrau



Bromo



Pastellblau

Matt lackiert	
Glänzend lackiert	
Offenporig	
Glänzendes Glas	
Satiniertes Glas	

	173
	173
	273
	373
	473

	177
	177
	277
	377
	477

	176
	176
	276
	376
	476

	155
	155
	255
	355
	455



Mimetic Grün



Onyx



Myrte



Waldgrün

Matt lackiert	
Glänzend lackiert	
Offenporig	
Glänzendes Glas	
Satiniertes Glas	

	166
	166
	266
	366
	466

	167
	167
	267
	367
	467

	165
	165
	265
	365
	465

	168
	168
	268
	368
	468



Salbeigrün



Kurkuma



Safrangelb



Terracotta

Matt lackiert	
Glänzend lackiert	
Offenporig	
Glänzendes Glas	
Satiniertes Glas	

	159
	159
	259
	359
	459

	169
	169
	269
	369
	469

	158
	158
	258
	358
	458

	170
	170
	270
	370
	470



Pfirsich



Rubinrot



Tabasco



Bordeaux

Matt lackiert	
Glänzend lackiert	
Offenporig	
Glänzendes Glas	
Satiniertes Glas	

	157
	157
	257
	357
	457

	172
	172
	272
	372
	472

	171
	171
	271
	371
	471

	156
	156
	256
	356
	456

Schranksystem

contur
MODERN INTERIOR DESIGN